









BOÎTIER DE TYPE "NON IC"
NW2675CA

	4 5/16" (109.5 mm)
	oui
Voltage	120 VOLTS
	
	
	PAR30 75W max.
	
	
	T°C 100°C No 027
	E 174023
Numéro UL	
E Électronique M Magnétique C Court L Long	

FINITIONS DISPONIBLES :
 B2675

 **Perçage : 4 5/8" (117 mm)**

NOTES:
 Accès facile sous le plafond
 Pour plafond sans isolation.

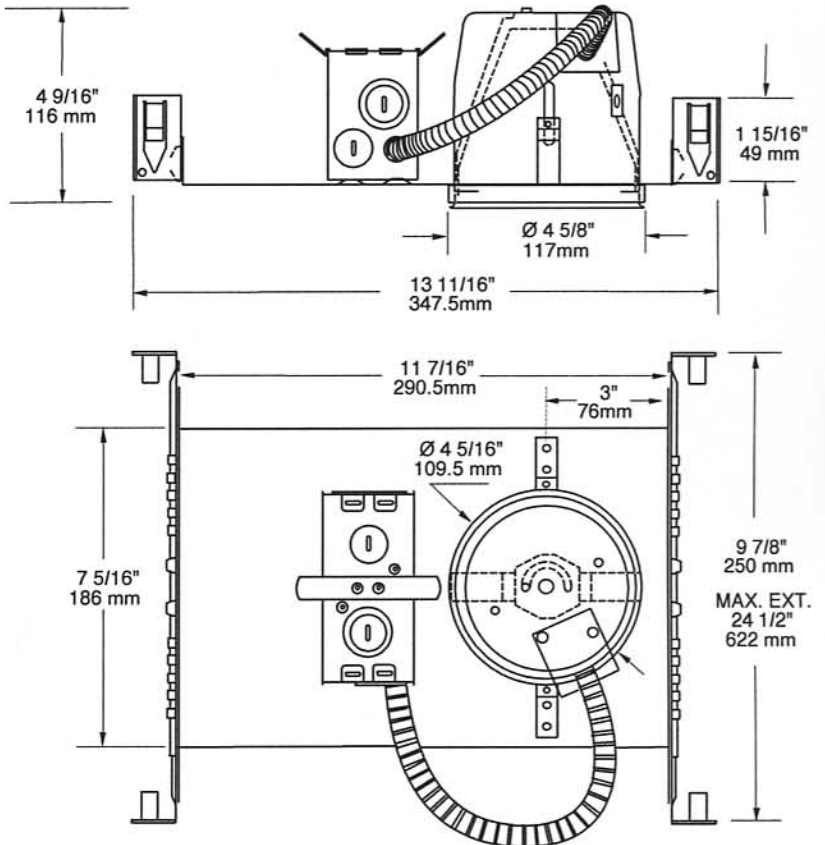

PROJET

Votre projet : _____

Représentant: _____