











"NON-IC" TYPE HOUSING
NW2675CA

-  **25°**
-  **yes**
- VOLTAGE 120 VOLTS**
-  _____
-  _____
-  **PAR30 75W max.**
-  _____
-  _____
-  **T°C 100°C No 027**
-  **Double top**
- UL number : E 174023**
- E Electronic M Magnetic C Short L Long**

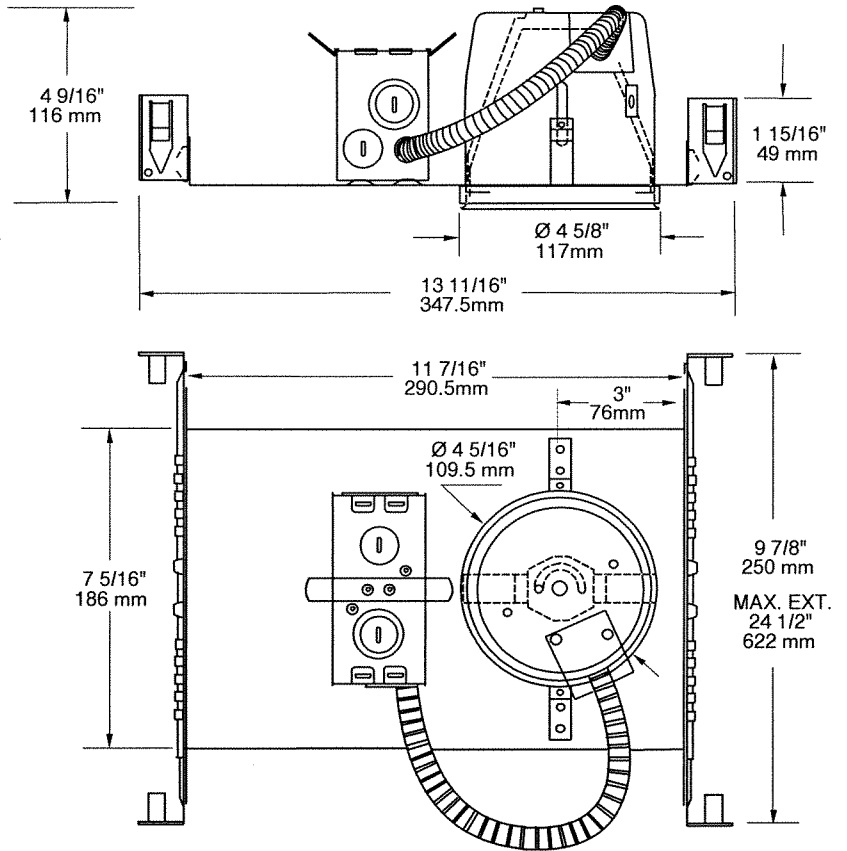

 **OD Cut : 4 5/8" (117 mm)**

NOTES:
 For ceiling without insulation
 Below ceiling access



PROJECT

Your Project: _____

Representative: _____