









SPECIFICATION SHEET

4" 2000 SERIES

MH2000PAR

REMODEL HOUSING FOR METAL HALIDE LAMP

	YES
Damp Location	
	PAR20 39W MED. M130
PAR20 HID	
	120 VOLTS (CAN & USA)
Voltage	
	Electronic Ballast
	Induction thermal protector
Thermal Protector	
	4 1/4" (108 mm)
Ceiling cutout	
	E331150
UL LISTED	
	Overall Dimensions Length : 14 7/8" (378mm) Width : 5 1/8" (130 mm) Height : 6" (152 mm)
Dimensions	

Codification

HOUSING TYPE	SERIE	LAMP	VOLTAGE	WATTAGE
MH	2000	PAR	1	39

Metal Halide High Intensity Discharge
4" PAR20 120 V 39 Watts

COMPATIBLE TRIMS 39W PAR20 MED.

A2000
A2100

TECHNICAL SPECIFICATIONS

0.051" (1.3 mm) thickness Galvanized Steel.
Below-ceiling accessible.
Hooks PAT#CAN 2,088,648 and #USA 5,377,088.
Installs to ceilings up to 7/8" (38 mm) thick.
Perfect fit into ceiling. No light leakage.
Each part of the case should be at 3" (76 mm) away MINIMUM from insulation (if applicable)
Thermal protector against unauthorized use of insulation.
4 Kv Pulse Rated.
120V «A» Class Converter. HPF > 0.95, THD < 6% and end of life protection
Auto Reset
Outdoor Type 1
Converter 4 year Warranty

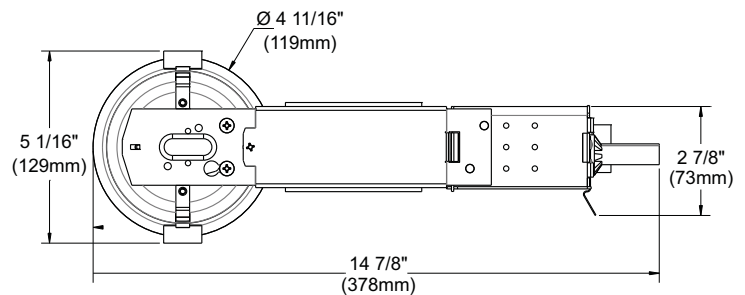
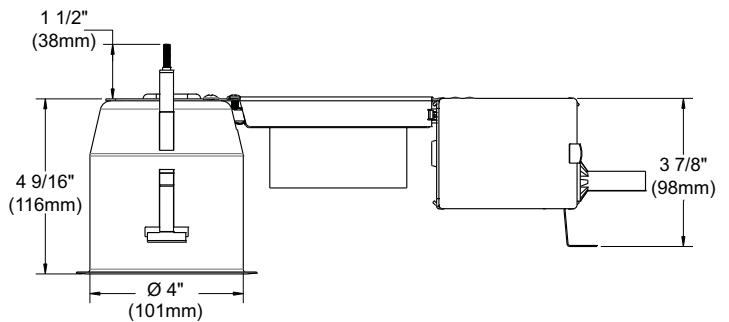
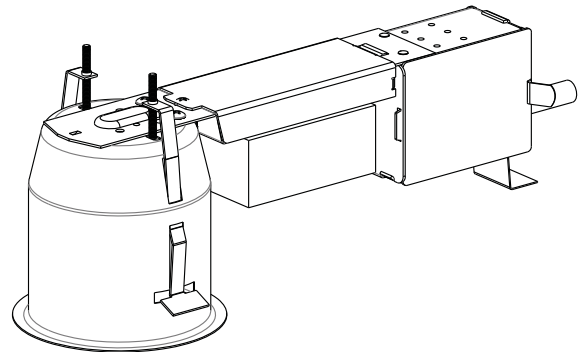

Project _____

Representative _____

CONTRAST
LIGHTING

1009, rue du Parc Industriel, Saint-Jean-Chrysostome QC G6Z 1C5, Canada Tel: 1-888-839-4624 Fax: 1-877-839-7057
info@contrastlighting.com
www.contrastlighting.com

2012-10