

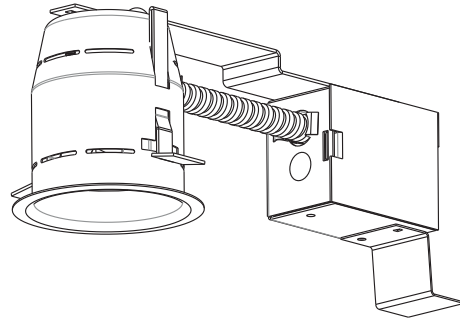







SPECIFICATION SHEET

2 1/2" 5000 SERIES

IT5000CE IT5000CE2

SHALLOW REMODEL HOUSING WITH ELECTRONIC CONVERTER



	YES
Damp Location	
	MR11 20W MAX
MR11	
	Electronic Converter 120V/12V Electronic Converter 277V/12V
	IT5000CE : 120 VOLTS (CAN & USA) IT5000CE2 : 277 VOLTS (USA)
Voltage	
	T°C 95°C No 026
Thermal Protector	
	2 5/8" (67mm)
OD Cut	
	E174023
UL LISTED	
	Overall Dimensions : Length : 9 1/2" (242mm) Width : 3 11/16" (94mm) Height : 3 1/4" (83mm)
Dimensions	

COMPATIBLE TRIMS

MR11 20W

T5000
T5200
T5250
T5300

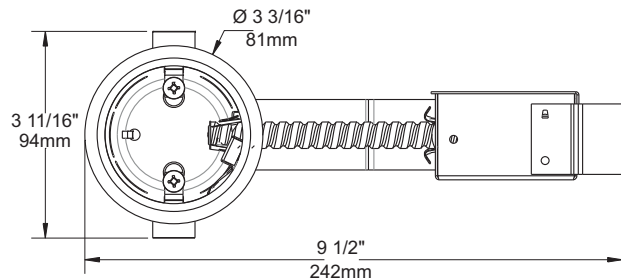
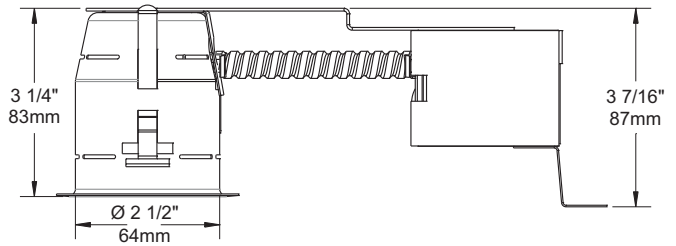

TECHNICAL SPECIFICATIONS

0,021" (0,53mm) thickness Galvanized Steel.
Below-ceiling accessible.
Takes up to 7/8" thick ceiling.
Perfect fit into ceiling.
No light leak.



Your representative : _____

Your project : _____

CONTRAST
LIGHTING

1009, rue du Parc Industriel, Saint-Jean-Chrysostome, Qc, CAN, G6Z1C5 Tel.: 1-888-839-4624 Fax : 1-877-839-7057
info@contrastlighting.com
www.contrastlighting.com

FEBRUARY 2010