

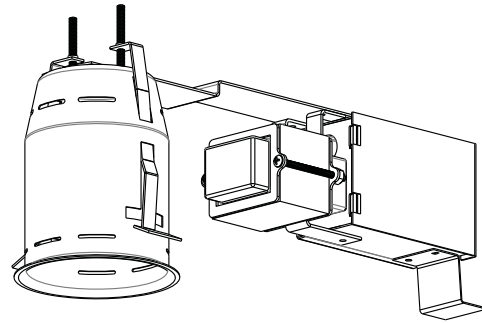







SPECIFICATION SHEET

3" 4000 SERIES

IT4000M

REMODEL HOUSING WITH
MAGNETIC TRANSFORMER



	YES
	MR16 35W MAX
	Magnetic Transformer 120V/12V
	IT4000M: 120 VOLTS (CAN & USA)
	T°C 105°C No 029
	3 1/4" (82mm)
	E174023
	Overall Dimensions: Length: 13" (330mm) Width: 4 1/4" (108mm) Height: 6" (152mm)

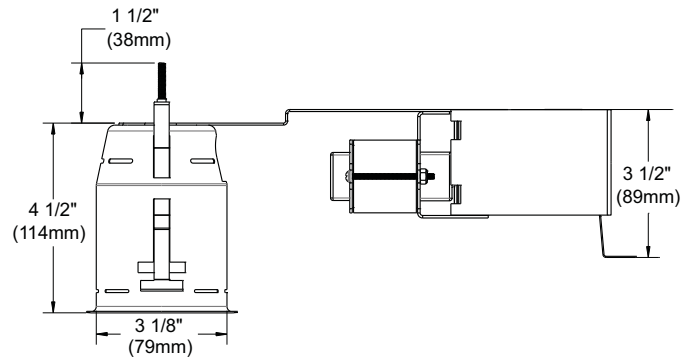

COMPATIBLE TRIMS

MR16 35W	MR16 20W
T4000	S4151
T4125	S4450
T4200	T4145
T4200V	T4450
T4210V	T4650
T4300	

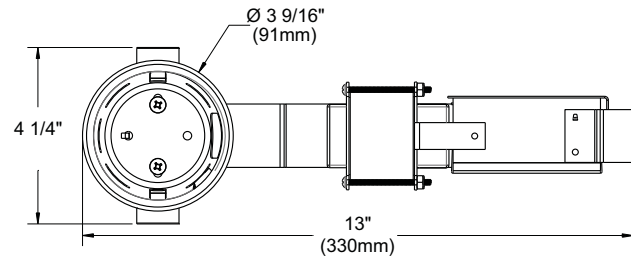

TECHNICAL SPECIFICATIONS

0,021" (0,53mm) thickness Galvanized Steel.
Below-ceiling accessible.
Hooks PAT#CAN 2,088,648 and #USA 5,377,088.
Takes up to 7/8" thick ceiling.
Perfect fit into ceiling.
No light leak.



Your representative: _____

Your project: _____