

# Ardito LED Remodel Housings

## 3-1/2" and 4" Series

DO NOT INSTALL IN INSULATION – SUITABLE FOR DAMP LOCATION

REA3V1, REA3V2, REA3VL, REA4V1, REA4V2, REA4VL

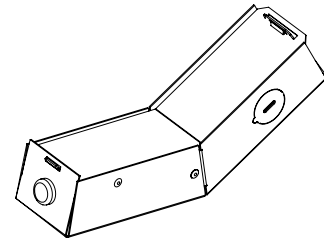

**Note:** Please refer to the specific section(s) of installation instructions according to the various options of this product.

**Section 1 (optional):** New Construction Mounting Plate Installation

**Section 2:** Remodel Installation

### Section 1 (optional): New Construction Mounting Plate Installation

1. Locate position of mounting plate before installing the ceiling material. Fasten the mounting plate to the wood joist (or other ceiling type) with the adjustable mounting bars (10" (254 mm) to 24.5" (622 mm)). To shorten the bars to 10" (254 mm), remove bars and cut off at the notch (see adjustable mounting bars detail view).
2. Once the correct bar length is known, press tabs to lock the mounting bars to the plate or using pliers, tighten the U-shaped hooks on the T-bars.

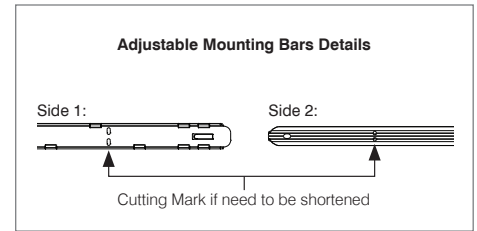
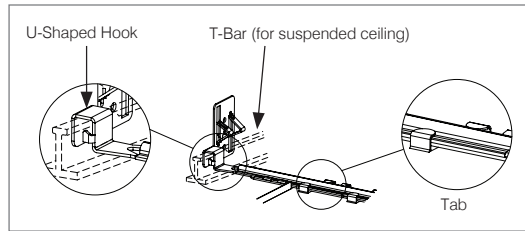
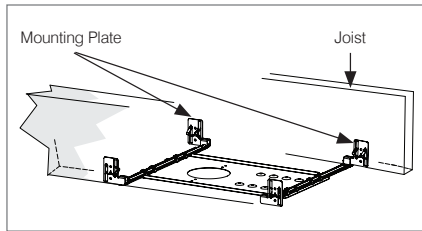

### Section 2 : Remodel Installation

1. **SHUT OFF ELECTRICAL SUPPLY AT SOURCE.**
2. Bring the electrical wiring to the junction box, according to your local electrical code.
3. Cut the exact hole dimension as per the following:

- 3-1/2" Round Trims:  $\varnothing$  3-3/4" (95 mm)
- 3-1/2" Square Trims: 3-3/4" (95 mm) x 3-3/4" (95 mm)
- 4" Round Trims:  $\varnothing$  4-1/4" (108 mm)
- 4" Square Trims: 4-1/4" (108 mm) x 4-1/4" (108 mm)

**IMPORTANT:** As the trim flange is very thin and narrow, the edges of the hole must be clear, precise and without notches so that the trim fits perfectly in the ceiling.

**Note:** For square trim, it is strongly recommended to use the cardboard cutout template included with the trim. A reusable steel cutout template is also offered as an accessory.

**Note:** Refer to the installation guide trim to know the minimal clearance recommended under the ceiling.

**Note:** For spacing guidelines on wall washer trims, please see their specification sheet.

4. Open the junction box cover (1) of the junction box (2) by pressing on the latch (3).

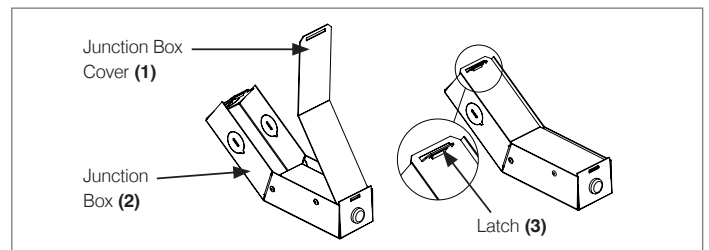

5. Insert the 120V/277V supply lead through a knockout. Make the electrical connections (see wiring diagram).

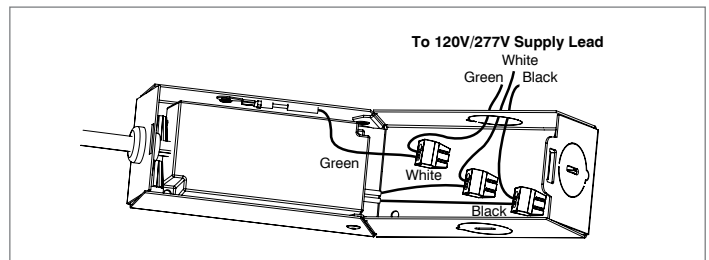

**WIRING DIAGRAMS**

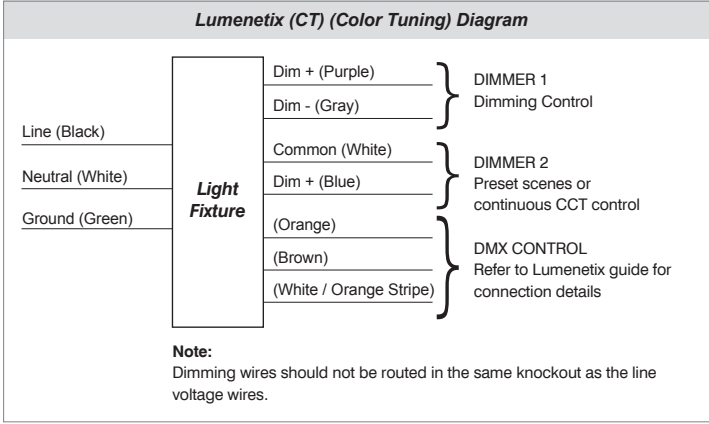
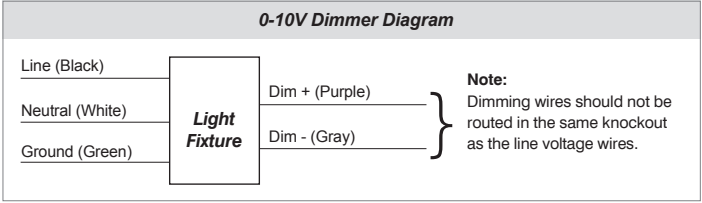
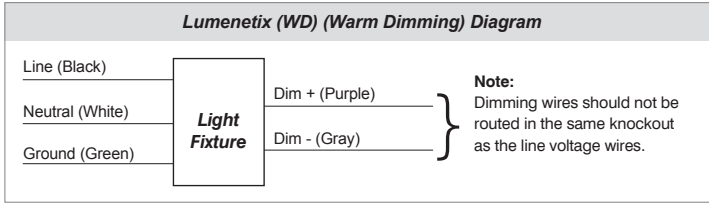
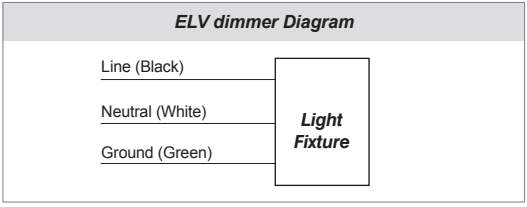

6. Close the junction box by pressing at the center of the cover **(1)**. Make sure it is properly closed.
7. Insert the junction box **(2)** through the hole cut and place it on the ceiling material or on the new construction mounting plate **(optional)**.
8. Keep junction box connector **(3)** accessible.
9. Complete the installation. Refer to the installation guide of the chosen trim.

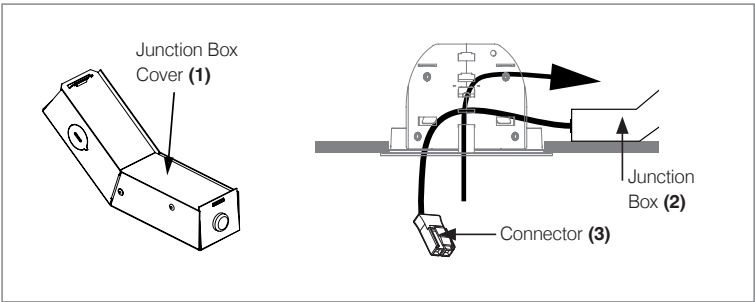

Please keep these instructions for future reference.



**WARNING**  
The use of other company's (non-Contraste) products or components (ex. trims) in conjunction with Contrast Lighting M.L. Inc. products may not be covered by UL approvals, and could be hazardous. Such use automatically voids all Contrast Lighting M.L. Inc. warranty and responsibility of these products.

**WARNING: RISK OF FIRE**  
Most dwellings built before 1985 have supply wires rated 60° C. Consult a qualified electrician before installing.

**It is very important not to exceed the lamp's indicated wattage.**

**Due to constant evolution of dimmers we must test them regularly. We invite you to frequently visit our Web site to find our dimmer compatibility list: [www.contrastlighting.com](http://www.contrastlighting.com)**

**WARRANTY:** CONTRAST LIGHTING M. L. INC. guarantees the components against manufacturing defects for a period of one (1) year, under normal use with proof of purchase. The obligation of the manufacturer consists in the cost of the components and does not cover the cost of labor and transport for replacement. For all claims, please contact your local supplier. See our Web site for additional warranty details. **Note:** 5-year warranty on driver and LED module.