











FEUILLE DE SPÉCIFICATION BOÎTIER DE TYPE "NON IC"

PROJET No:

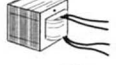
NW4000M 120/12V

	oui
	120 VOLTS
	12 V 35W max.
	
	
	
	EC 35M 35 VA 120V / 12V
	T°C 120°C No 031
	E 174023
E Électronique M Magnétique C Court L Long	

FINITIONS DISPONIBLES :
T4000, T4200, T4200V, T4210V, T4230V, T4300

 Perçage : 3 1/4" (82 mm)

NOTES:
Nécessite un accès par le plafond
Transformateur magnétique de 50W
disponible en 277/12V et 347/12V

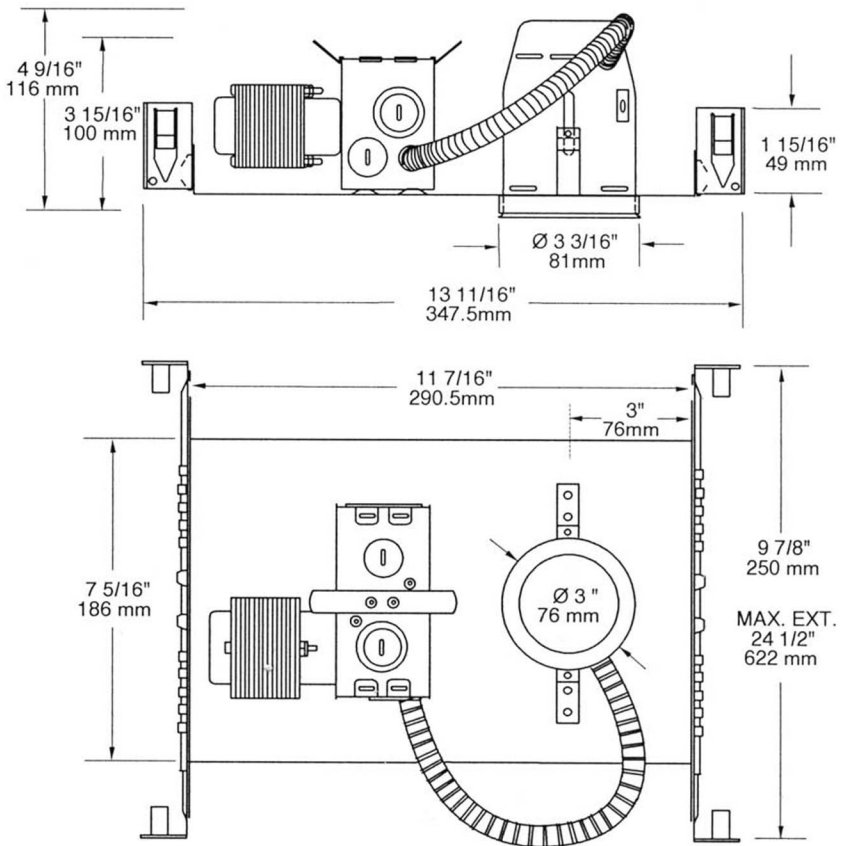

PROJET

Votre projet : _____

Représentant: _____