









BOÎTIER DE TYPE "NON IC"
NW2000CA

	4" (101.5 mm)
	oui
Voltage	120 VOLTS
	
	
	PAR20 50W max.
	
	
	T°C 100°C No 027
Numéro UL	E 174023
E Électronique M Magnétique C Court L Long	

FINITIONS DISPONIBLES :
 A2000, A2000V, A2010V

 **Perçage : 4 1/4" (107 mm)**

NOTES:
 Accès facile sous le plafond
 Pour plafond sans isolation.

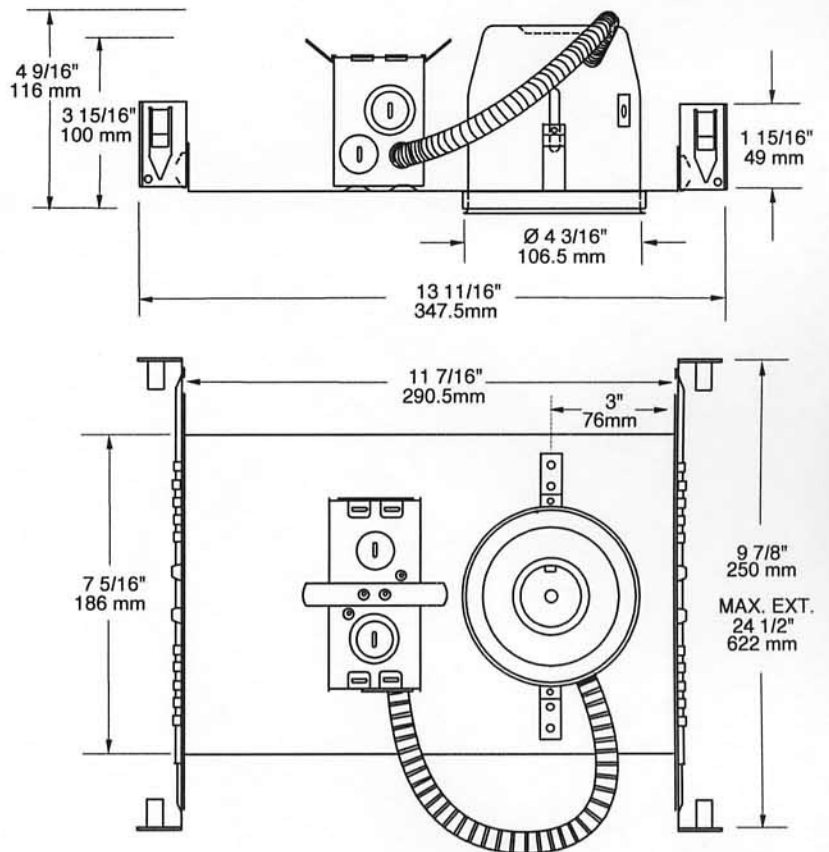

PROJET

Votre projet : _____

Représentant: _____