











BOÎTIER DE TYPE "IC"
ISMR3000E20

	_____
	_____
Voltage	120 VOLTS
	12 V 20W max.
	_____
	_____
	_____
	_____
	120V/12V
	T°C 95°C No 026
Double toit	non
Numéro UL	E 174023

M Magnétique E Électronique C Court L Long
BOÎTIER "AIR TIGHT"

FINITIONS DISPONIBLES :
 T3000, T3100, T3200, T3250, T3260, T3300
 T3400, T3450, T3500, T3600, T3650, T3700
 T3800, T3850, T3900, S3400, S3450, S3500
 S3400D, S3450D, S3500D.

 **Perçage : 3 3/4" (95 mm)**

NOTES: Accès facile sous le plafond
 Pour plafond avec isolation.

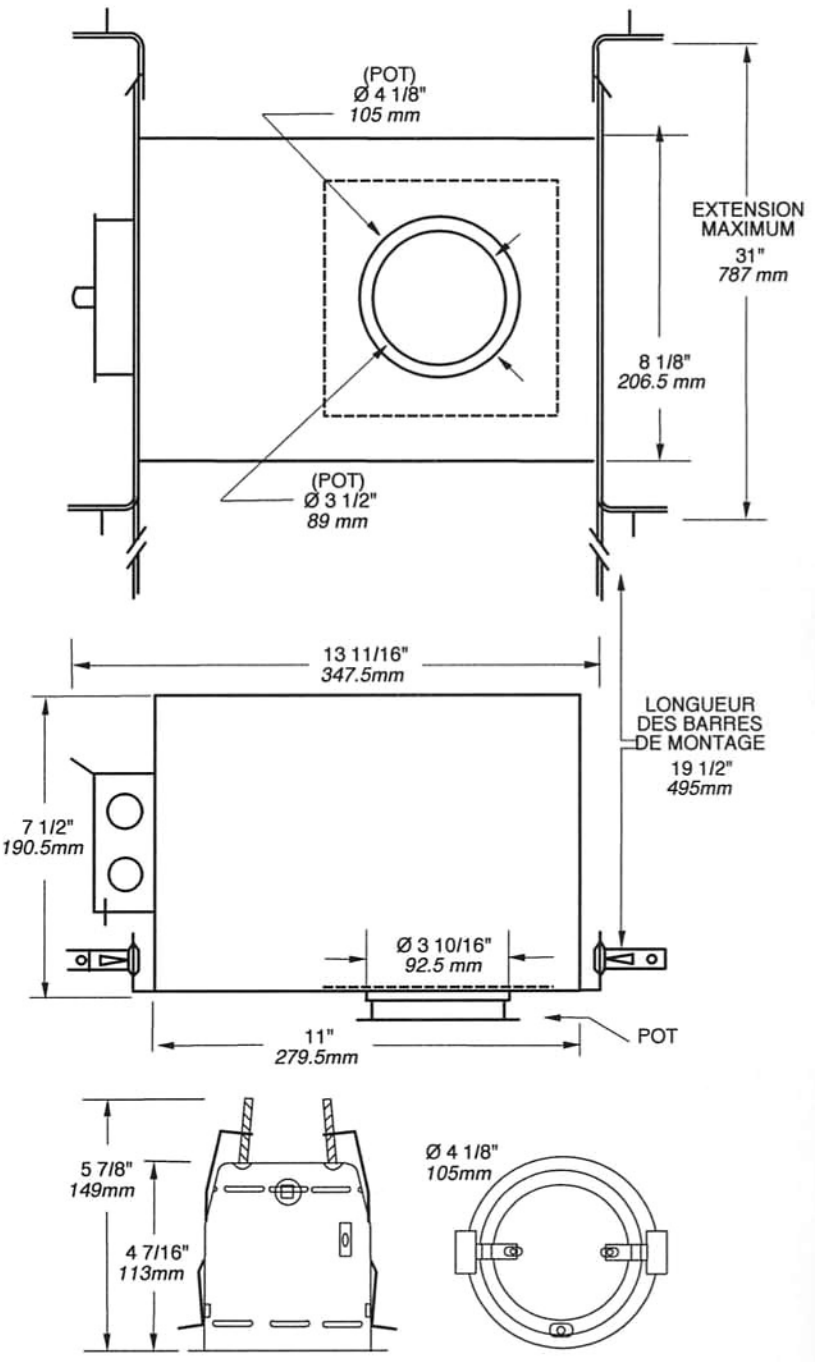

PROJET

Votre projet : _____

Représentant: _____