















# SPECIFICATION SHEET

3 1/2" LOW VOLTAGE MR16

## T3250 - LOW PROFILE ADJUSTABLE

PROJECT No:

-  \_\_\_\_\_ 30° \_\_\_\_\_
-  \_\_\_\_\_
-  \_\_\_\_\_ **yes** \_\_\_\_\_
-  \_\_\_\_\_ **MR16 20-50W** \_\_\_\_\_
-  \_\_\_\_\_
-  \_\_\_\_\_
-  \_\_\_\_\_
-  \_\_\_\_\_
-  \_\_\_\_\_ **NW3000CM / NW3000LM** \_\_\_\_\_
-  \_\_\_\_\_ **IT3000E / IT3000CE / IT3000LE** \_\_\_\_\_
-  \_\_\_\_\_ **IT3000M / IT3000CM / IT3000LM** \_\_\_\_\_
-  \_\_\_\_\_ **ISMR3000E20 / ISMR3000M20** \_\_\_\_\_
-  \_\_\_\_\_ **ISMR3000E35 / ISMR3000M35** \_\_\_\_\_
-  \_\_\_\_\_ **ISMR3000M37 / ISMR3000M** \_\_\_\_\_

**E** Electronic **M** Magnetic **C** Short **L** Long

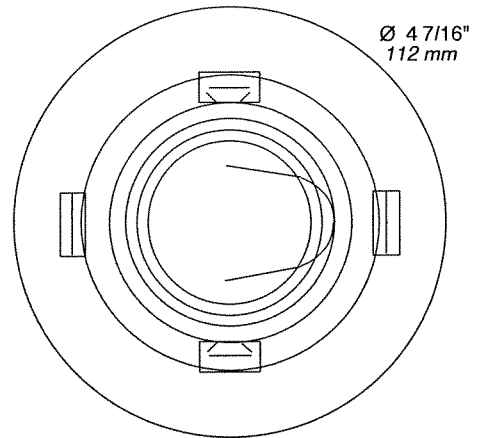
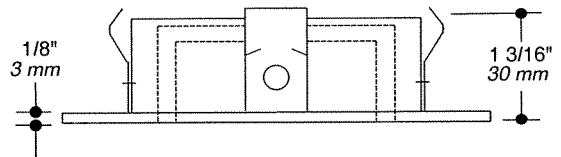
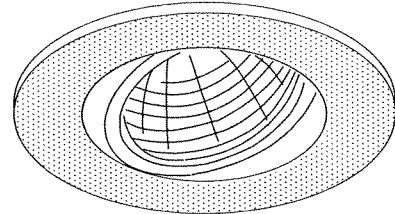

### NOTES:

*UNLESS OTHERWISE INDICATED,  
ALL TRIMS SERIES ARE FOR INTERIOR USE ONLY.*

THE BLACK POTS ARE OPTIONAL

### TRIM FINISH

- |                             |                             |
|-----------------------------|-----------------------------|
| 01- WHITE                   | 07- ANTIQUE BRASS PLATED    |
| 02- BLACK                   | 08- ANTIQUE SILVER PLATED   |
| 03- 24K GOLD PLATED         | 09- MAHOGANY                |
| 04- CHROME PLATED           | 11- MATTE WHITE             |
| 04BR- BRUSHED CHROME PLATED | 12BR- BRUSHED NICKEL PLATED |
| 05- ARCHITECTURAL BRONZE    | 13- SATIN NICKEL PLATED     |
| 06- ANTIQUE COPPER          | 14- ALMOND                  |



## PROJECT

Your Project: \_\_\_\_\_

Representative: \_\_\_\_\_