













SPECIFICATION SHEET

4" LOW VOLTAGE MR16

PROJECT No:

S2001 - LOW PROFILE SHOWER DOWNLIGHT

-  _____
-  _____
-  **yes (Wet location)**
-  **MR16 20-50W**
-  _____
-  _____
-  _____
-  _____
-  _____
-  _____
-  _____
-  _____

NW2000CE (50W) / NW2000CM (50W)
NW2000E (50W) / NW2000LM (75W)

IT2000CE / IT2000CM (42W)
IT2000E / IT2000M (50W)

ISMR2000M (50W)

E Electronic M Magnetic C Short L Long

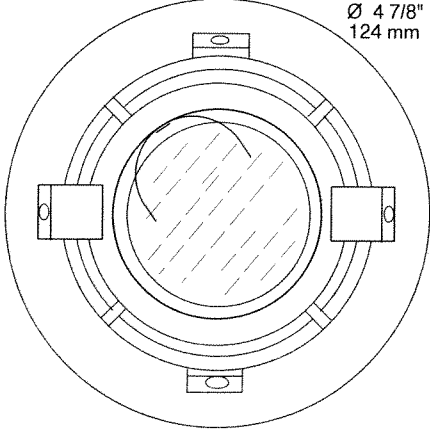
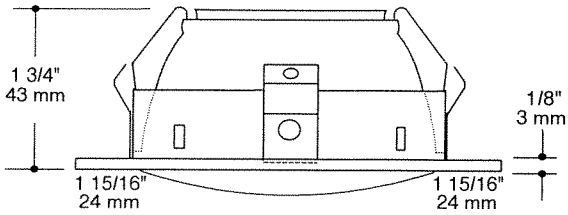
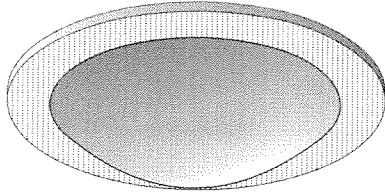

NOTES:
*UNLESS OTHERWISE INDICATED,
ALL TRIMS SERIES ARE FOR INTERIOR USE ONLY.*
Send with the Frosted Lens VITB83F Ø 3 1/4" (83 mm)
AVAILABLE: VITB83 (Clear and Convex lens)
VITB83F (Frosted and Convex lens)

TRIM FINISH

- | | |
|-----------------------------|-----------------------------|
| 01- WHITE | 07- ANTIQUE BRASS PLATED |
| 02- BLACK | 08- ANTIQUE SILVER PLATED |
| 03- 24K GOLD PLATED | 09- MAHOGANY |
| 04- CHROME PLATED | 11- MATTE WHITE |
| 04BR- BRUSHED CHROME PLATED | 12BR- BRUSHED NICKEL PLATED |
| 05- ARCHITECTURAL BRONZE | 13- SATIN NICKEL PLATED |
| 06- ANTIQUE COPPER | 14- ALMOND |



Your Project: _____

Representative: _____