













SPECIFICATION SHEET

PROJECT No:

3 1/2" LINE VOLTAGE PAR20

**C2550 - TRIM COLLAR
(Requires Baffle / Reflector)**

-  _____
-  _____
-  **yes** _____
-  _____
-  _____
-  _____
-  _____
-  _____
-  _____
-  **NW2550CA** _____
-  **CA2550** _____
-  **ISCA2550** _____

E Electronic **M** Magnetic **C** Short **L** Long

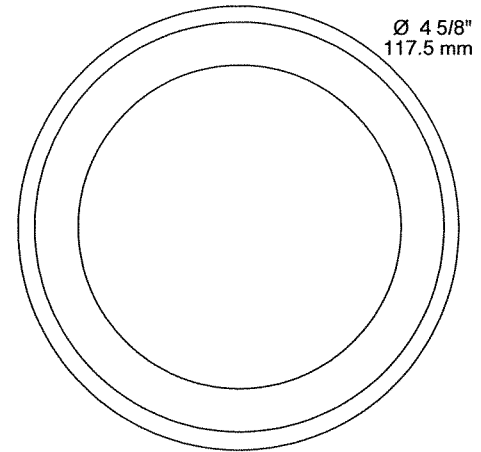
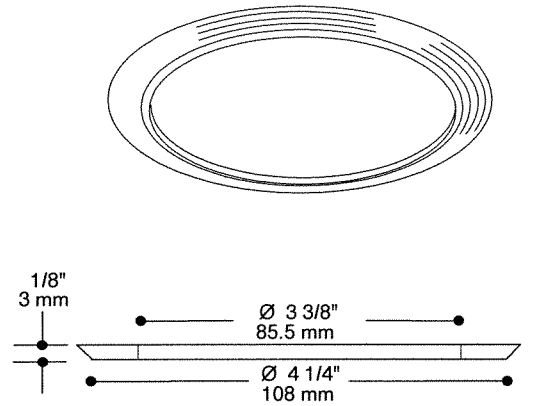

NOTES:

**UNLESS OTHERWISE INDICATED,
ALL TRIMS SERIES ARE FOR INTERIOR USE ONLY.**

With the NW2550CA Collar trim and grooved baffle are required.

TRIM FINISH

- 01- WHITE
- 02- BLACK
- 03- 24K GOLD PLATED
- 04- CHROME PLATED
- 04BR- BRUSHED CHROME PLATED
- 05- ARCHITECTURAL BRONZE
- 06- ANTIQUE COPPER
- 07- ANTIQUE BRASS PLATED
- 08- ANTIQUE SILVER PLATED
- 09- MAHOGANY
- 11- MATTE WHITE
- 12BR- BRUSHED NICKEL PLATED
- 13- SATIN NICKEL PLATED
- 14- ALMOND



PROJECT

Your Project: _____

Representative: _____