









**SPECIFICATION SHEET**

3 1/2" LINE VOLTAGE PAR20

**A3600 - BEVELED DOWNLIGHT**

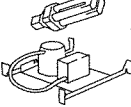
**PROJECT No:**  
\_\_\_\_\_

-  \_\_\_\_\_
-  \_\_\_\_\_
-  **yes** \_\_\_\_\_
-  \_\_\_\_\_
-  **PAR20 50W** \_\_\_\_\_
-  \_\_\_\_\_
-  \_\_\_\_\_
-  **NW3600CA** \_\_\_\_\_
-  **CA3600** \_\_\_\_\_
-  **ISCA3600** \_\_\_\_\_

**E** Electronic **M** Magnetic **C** Short **L** Long

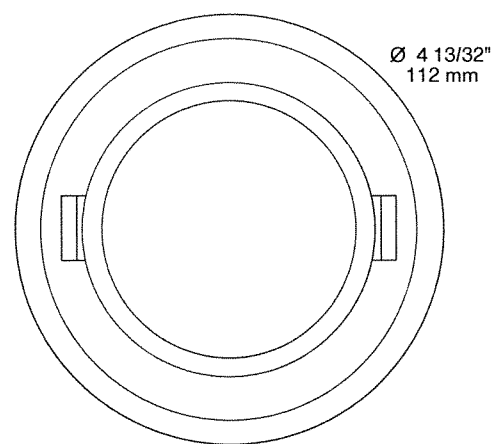
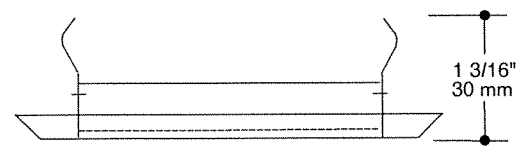
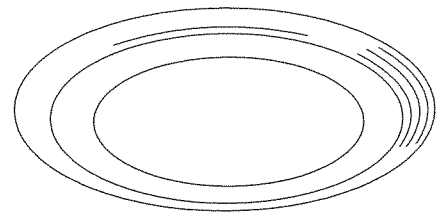

**NOTES:**  
*UNLESS OTHERWISE INDICATED,  
ALL TRIMS SERIES ARE FOR INTERIOR USE ONLY.*

**TRIM FINISH**

- |                             |                             |
|-----------------------------|-----------------------------|
| 01- WHITE                   | 07- ANTIQUE BRASS PLATED    |
| 02- BLACK                   | 08- ANTIQUE SILVER PLATED   |
| 03- 24K GOLD PLATED         | 09- MAHOGANY                |
| 04- CHROME PLATED           | 11- MATTE WHITE             |
| 04BR- BRUSHED CHROME PLATED | 12BR- BRUSHED NICKEL PLATED |
| 05- ARCHITECTURAL BRONZE    | 13- SATIN NICKEL PLATED     |
| 06- ANTIQUE COPPER          | 14- ALMOND                  |



**PROJECT**

Your Project: \_\_\_\_\_

Representative: \_\_\_\_\_