









SPECIFICATION SHEET

"NON-IC" TYPE HOUSING

F2575R

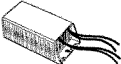
PROJECT No:

	_____
VOLTAGE	yes _____ 120 VOLTS _____
	_____
	_____
	_____
	1 x 13W GX23-2 2PIN DTT _____
	H.P.F.magnetic Ballast _____
	_____
	_____
BX Length	_____
UL number	E 175084 _____

E Electronic **M** Magnetic **C** Short **L** Long

TRIM IS REQUIRED

 OD Cut : 4 5/8" (118 mm)

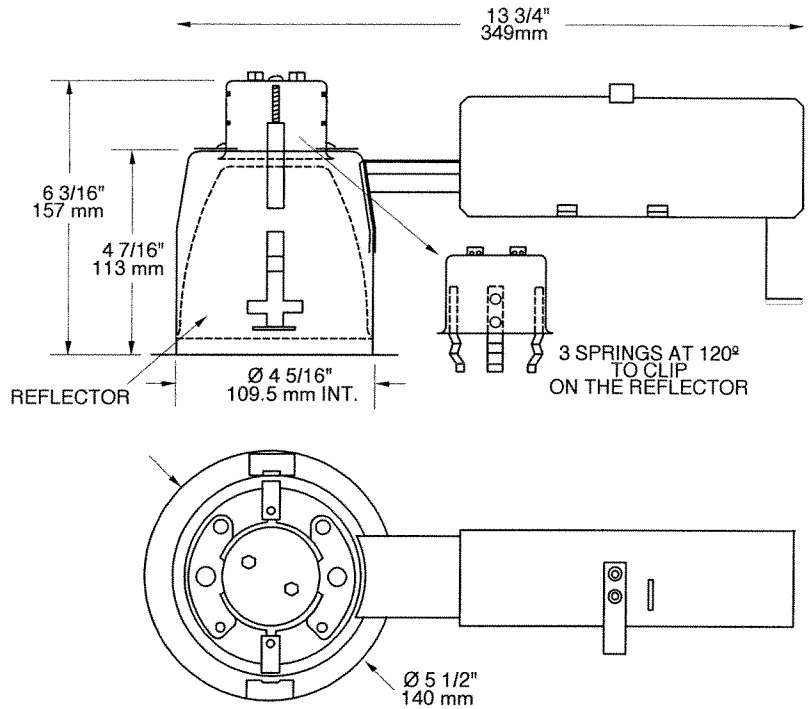

TECHNICAL SPECIFICATIONS

<p>HOUSING FEATURES Galvanized steel Preset socket assembly and Keyhole on socket assembly for easier installation Below ceiling accessible See specs housing section</p>	<p>LOCKING SYSTEM Perfect fit to ceiling No light leak Hooks PAT#CAN.2.088.648 and #USA.5.377.088 Take up to 7/8" thick ceilings</p>	<p>BALLAST 120V Class P HPF Magnetic ballast instant start 2 Year Warranty</p>	<p>SOCKET High temperature-rated 130° C instead of 90° C Stainless Steel contacts</p>	<p>LISTINGS UL-cUL Listed for through branch wiring and damp location</p>
--	---	---	--	--

Your Project: _____

Representative: _____

