

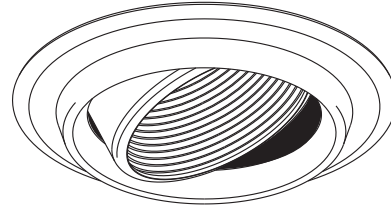







# SPECIFICATION SHEET

3 1/2" 3000 SERIES

# T3500D

DECOR ADJUSTABLE REGRESSED TRIM WITH PAINTED STEPPED REFLECTOR (ST)



	YES
<b>Damp Location</b>	
	20-50W
<b>MR16</b>	
	50W*
<b>GU/GZ-10</b>	
	<p><b>Painted stepped reflector</b> Available colors : White (-01), Black (-02), Matte White (-11). Code examples : To order a white trim with a white reflector : <b>T3500D-01-01ST</b> To order a white trim with a black reflector : <b>T3500D-01-02ST</b> To order a white trim with a matte white reflector : <b>T3500D-01-11ST</b></p>
<b>Reflector</b>	
	<p><b>Insulated ceiling housing</b> ISMR3000E20, ISMR3000E35, ISMR3000M, ISMR3000M20, ISMR3000M35, ISMR3000T*</p>
<b>Insulated ceiling housing</b>	
	<p><b>New construction housing</b> NW3000CE, NW3000CM, NW3000LE, NW3000LM, NW3000LT*</p>
<b>New construction housing</b>	
	<p><b>Remodel housing</b> IT3000CE, IT3000CM, IT3000E, IT3000M, IT3000LE, IT3000LM, IT3000LT*</p>
<b>Remodel housing</b>	

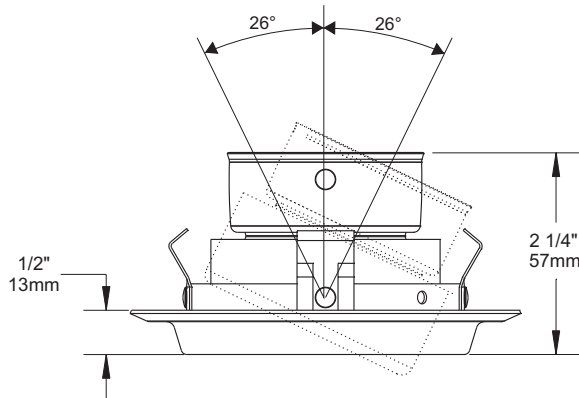

## COMPATIBLE HOUSINGS

50W GU-GZ/10	50W MR16	35W MR16	20W MR16
ISMR3000T*	ISMR3000M	NW3000CE	ISMR3000E35
IT3000LT*	IT3000E	NW3000CM	ISMR3000M35
NW3000LT*	IT3000M	NW3000LE	IT3000CE
	IT3000LE	NW3000LM	IT3000CM
	IT3000LM		

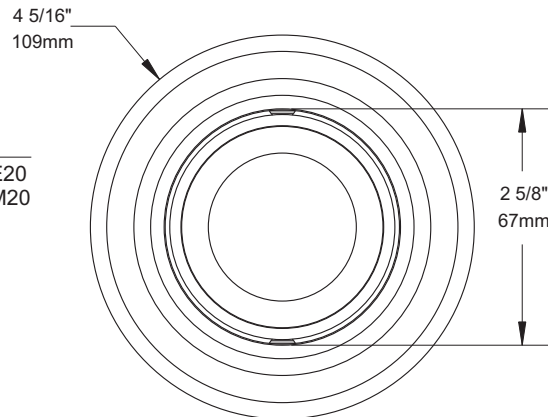

## TRIM FINISHES

-01 WHITE	-04BR BRUSHED CHROME	-08 ANTIQUE SILVER
-02 BLACK	-05 ARCHITECTURAL BRONZE	-11 MATTE WHITE
-03 24K GOLD	-06 ANTIQUE COPPER	-12BR BRUSHED NICKEL
-04 CHROME	-07 ANTIQUE BRASS	-13 SATIN NICKEL
		-14 ALMOND

Unless otherwise indicated, trims are for **interior use only**. For exterior use and up to wet conditions, **MARINE GRADE** treatment is **recommended**. Available for finishes -01, -02, -05, -06, -11 and -14 only.



Certified UL Standards

Project \_\_\_\_\_

Representative \_\_\_\_\_

**CONTRAST**  
LIGHTING

1009, rue du Parc Industriel, Saint-Jean-Chrysostome, Qc, CAN G6Z 1C5 Tel.: 1-888-839-4624 Fax : 1-877-839-7057  
info@contrastlighting.com  
www.contrastlighting.com

APRIL 2010