

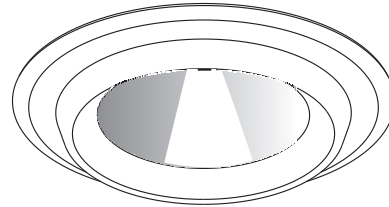







SPECIFICATION SHEET

3 1/2" 3000 SERIES

T3500

DECOR REGRESSED TRIM



	YES																		
Damp Location																			
	20-50W																		
MR16																			
	50W*																		
GU/GZ-10																			
	<p>Standard : Anodized aluminum Available :</p> <table border="0"> <tr> <td>Anodized</td> <td>Specular</td> <td>Painted</td> </tr> <tr> <td>Azur (AZ)</td> <td>Black (BK)</td> <td>White (-01)</td> </tr> <tr> <td>Burnt orange (BO)</td> <td>Champagne (CH)</td> <td>Black (-02)</td> </tr> <tr> <td>Cobalt blue (CB)</td> <td>Clear (CL)</td> <td>Matte White (-11)</td> </tr> <tr> <td>Inca Gold (IG)</td> <td></td> <td></td> </tr> <tr> <td>Ruby (RU)</td> <td></td> <td></td> </tr> </table> <p>To order a white trim with the standard reflector : T3500-01 To order a white trim with an Azur smooth reflector : T3500-01AZ</p>	Anodized	Specular	Painted	Azur (AZ)	Black (BK)	White (-01)	Burnt orange (BO)	Champagne (CH)	Black (-02)	Cobalt blue (CB)	Clear (CL)	Matte White (-11)	Inca Gold (IG)			Ruby (RU)		
Anodized	Specular	Painted																	
Azur (AZ)	Black (BK)	White (-01)																	
Burnt orange (BO)	Champagne (CH)	Black (-02)																	
Cobalt blue (CB)	Clear (CL)	Matte White (-11)																	
Inca Gold (IG)																			
Ruby (RU)																			
	<p>Insulated ceiling housing ISMR3000E20, ISMR3000E35, ISMR3000M, ISMR3000M20, ISMR3000M35, ISMR3000T*</p>																		
	<p>New construction housing NW3000CE, NW3000CM, NW3000LE, NW3000LM, NW3000LT*</p>																		
	<p>Remodel housing IT3000E, IT3000M, IT3000LE, IT3000LM, IT3000LT*</p>																		

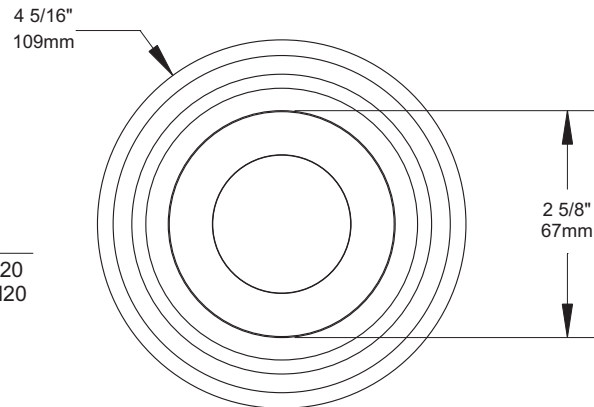
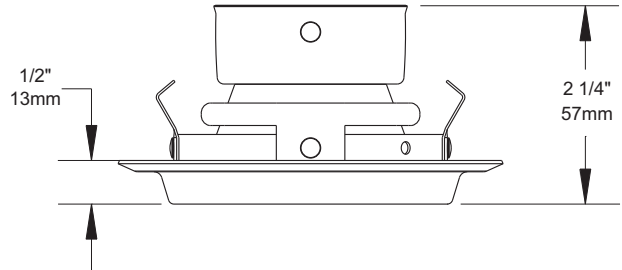

COMPATIBLE HOUSINGS

50W GU-GZ/10	50W MR16	35W MR16	20W MR16
ISMR3000T*	ISMR3000M	NW3000CE	ISMR3000E35
IT3000LT*	IT3000E	NW3000CM	ISMR3000M35
NW3000LT*	IT3000M	NW3000LE	ISMR3000E20
	IT3000LE	NW3000LM	ISMR3000M20
	IT3000LM		

TRIM FINISHES

-01 WHITE	-04BR BRUSHED CHROME	-08 ANTIQUE SILVER
-02 BLACK	-05 ARCHITECTURAL BRONZE	-11 MATTE WHITE
-03 24K GOLD	-06 ANTIQUE COPPER	-12BR BRUSHED NICKEL
-04 CHROME	-07 ANTIQUE BRASS	-13 SATIN NICKEL
		-14 ALMOND

Unless otherwise indicated, trims are for **interior use only**. For exterior use and up to wet conditions, **MARINE GRADE** treatment is **recommended**. Available for finishes -01, -02, -05, -06, -11 and -14 only.



Project _____

Representative _____

CONTRAST
L I G H T I N G

1009, rue du Parc Industriel, Saint-Jean-Chrysostome, Qc, CAN G6Z 1C5 Tel.: 1-888-839-4624 Fax : 1-877-839-7057
info@contrastlighting.com
www.contrastlighting.com

APRIL 2010