







SPECIFICATION SHEET

3 1/2" 3000 SERIES

T3152

SQUARE TRIM WITH PINHOLE OPENING

	YES
Damp Location	
	20-50W
MR16	
	50W*
GU/GZ-10	
	DOES NOT APPLY
Reflector	
	Insulated ceiling housing ISMR3000E20, ISMR3000E35, ISMR3000M, ISMR3000M20, ISMR3000M35
	New construction housing NW3000LE, NW3000LM, NW3000CE, NW3000CM, NW3000LT*
	Remodel housing IT3000LE, IT3000LM
Remodel housing	

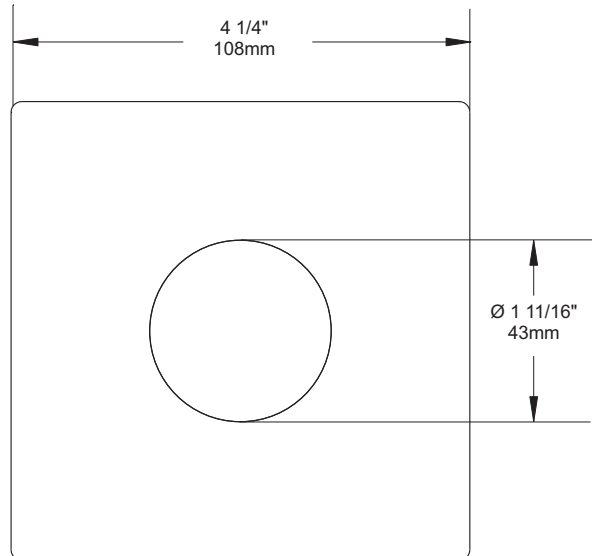
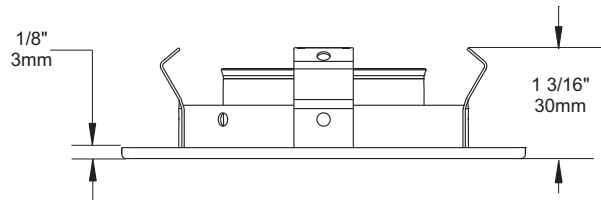
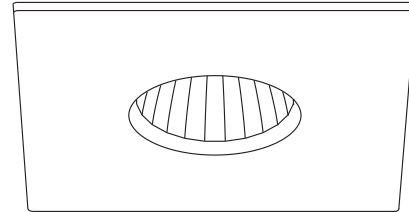

COMPATIBLE HOUSINGS

50W GU-GZ/10	50W MR16	37W MR16	35W MR16	20W MR16
NW3000LT*	IT3000LE IT3000LM NW3000LE NW3000LM	NW3000CE NW3000CM	ISMR3000E35 ISMR3000M ISMR3000M35	ISMR3000E20 ISMR3000M20

TRIM FINISHES

-01 WHITE	-04BR BRUSHED CHROME	-08 ANTIQUE SILVER
-02 BLACK	-05 ARCHITECTURAL BRONZE	-11 MATTE WHITE
-03 24K GOLD	-06 ANTIQUE COPPER	-12BR BRUSHED NICKEL
-04 CHROME	-07 ANTIQUE BRASS	-13 SATIN NICKEL
		-14 ALMOND

Unless otherwise indicated, trims are for **interior use only**. For exterior use and up to wet conditions, **MARINE GRADE** treatment is **recommended**. Available for finishes -01, -02, -05, -06, -11 and -14 only.



Project _____

Representative _____

CONTRAST
LIGHTING

1009, rue du Parc Industriel, Saint-Jean-Christophe, Qc, CAN G6Z 1C5 Tel.: 1-888-839-4624 Fax : 1-877-839-7057
info@contrastlighting.com
www.contrastlighting.com

APRIL 2010