

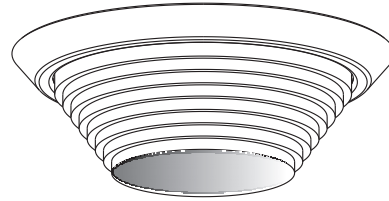





# SPECIFICATION SHEET

4" 2000 SERIES

# T2000V

FROSTED STEPPED GLASS TRIM

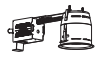

	YES
<b>Damp Location</b>	
	35-75W
<b>MR16</b>	
	50W*
<b>GU/GZ-10</b>	
	2 available colors : natural et blue. White trim with natural glass : T2000V-01 White trim with blue glass : T2010V-01
<b>Glass</b>	
	<b>Insulated ceiling housing</b> ISMR2000E35, ISMR2000M, ISMR2000M35 ISMR2000E37, ISMR2000M37, ISMR2000T*
	<b>New construction housing</b> NW2000E, NW2000CE, NW2000CM, NW2000LM, NW2000T*
	<b>Remodel housing</b> IT2000M, IT2000CM, IT2000E, IT2000CE, IT2000T*

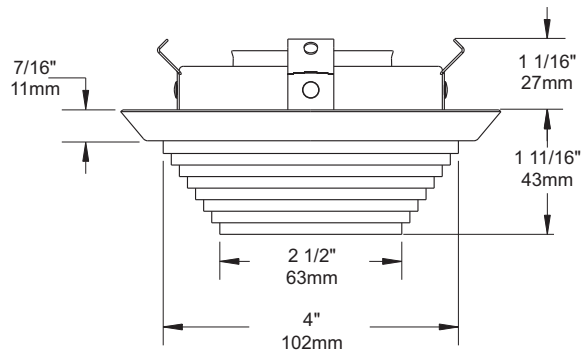

## COMPATIBLE HOUSINGS

50W GU-GZ/10	75W MR16	50W MR16
ISMR2000T IT2000T NW2000T	NW2000LM	ISMR2000M IT2000E IT2000M NW2000CM NW2000E
42W MR16	37W MR16	35W MR16
IT2000CE IT2000CM NW2000CE	ISMR2000E37 ISMR2000M37	ISMR2000E35 ISMR2000M35

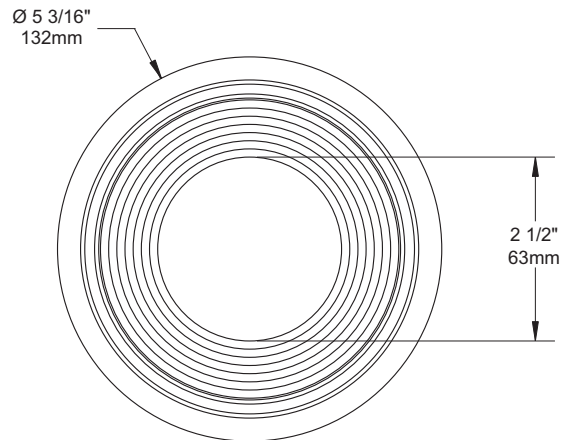

## TRIM FINISHES

-01 WHITE	-04BR BRUSHED CHROME	-08 ANTIQUE SILVER
-02 BLACK	-05 ARCHITECTURAL BRONZE	-11 MATTE WHITE
-03 24K GOLD	-06 ANTIQUE COPPER	-12BR BRUSHED NICKEL
-04 CHROME	-07 ANTIQUE BRASS	-13 SATIN NICKEL
		-14 ALMOND

Unless otherwise indicated, trims are for **interior use only**. For exterior use and up to wet conditions, **MARINE GRADE** treatment is **recommended**. Available for finishes -01, -02, -05, -06, -11 and -14 only.

**MADE IN CANADA**

**UL**  
LISTED  
Certified UL Standards

Project \_\_\_\_\_

Representative \_\_\_\_\_

**CONTRAST**  
LIGHTING

1009, rue du Parc Industriel, Saint-Jean-Chrysostome, Qc, CAN G6Z 1C5 Tel.: 1-888-839-4624 Fax : 1-877-839-7057  
info@contrastlighting.com  
www.contrastlighting.com

JULY 2010