







# SPECIFICATION SHEET

## 8" COMPACT FLUORESCENT SERIES

# NWF8

### NEW CONSTRUCTION HOUSING FOR HORIZONTAL LAMP

	<b>YES</b>		<b>E175084</b>
	<b>ELECTRONIC BALLAST</b>		
	<b>9 1/4" (235mm)</b>		
	<b>120-277 VOLTS (CAN &amp; USA.) 347 VOLTS (CAN)</b>		
	<b>26W, 32W or 42W</b>	26W : G24q-3 4 PIN DTT 32W : GX24q-3 4 PIN TTT 42W : GX24q-4 4 PIN TTT	

#### CODES :

NWF8 <u>U</u> 26	2 X 26W	G24q-3	DTT	120 to 277 VOLT <u>U</u> NIVERSAL BALLAST
NWF8 <u>U</u> 32	2 X 32W	GX24q-3	TTT	
NWF8 <u>U</u> 42	2 X 42W	GX24q-4	TTT	
NWF8 <u>3</u> 26	2 X 26W	G24q-3	DTT	347 VOLT BALLAST (FOR CANADA ONLY)
NWF8 <u>3</u> 32	2 X 32W	GX24q-3	TTT	
NWF8 <u>3</u> 42	2 X 42W	GX24q-4	TTT	
NWF8 <u>D</u> 26	2 X 26W	G24q-3	DTT	120 VOLT <u>D</u> IMMABLE BALLAST
NWF8 <u>D</u> 32	2 X 32W	GX24q-3	TTT	
NWF8 <u>D</u> 42	2 X 42W	GX24q-4	TTT	
NWF8 <u>D</u> 26 <u>2</u>	2 X 26W	G24q-3	DTT	277 VOLT <u>D</u> IMMABLE BALLAST (FOR U.S.A. ONLY)
NWF8 <u>D</u> 32 <u>2</u>	2 X 32W	GX24q-3	TTT	
NWF8 <u>D</u> 42 <u>2</u>	2 X 42W	GX24q-4	TTT	

#### COMPATIBLE TRIMS

FR8C	FR8OLA
FR8O	FR8OLB
FR8OM	FR8T



#### ENERGY STAR Requirements

**120 Volt ONLY**

- Lamp with a rated life of 10 000 hours or more, in these colors : 2700K, 3000K, 3500K or 4100K.

Generic lamp designation :

CFQ13W/G24q	CFQ26W/G24q	Combine housing with one of the following trims :
CFQ18W/G24q	CFTR26W/GX24q	
CFTR18W/GX24q	CFTR32W/GX24q	

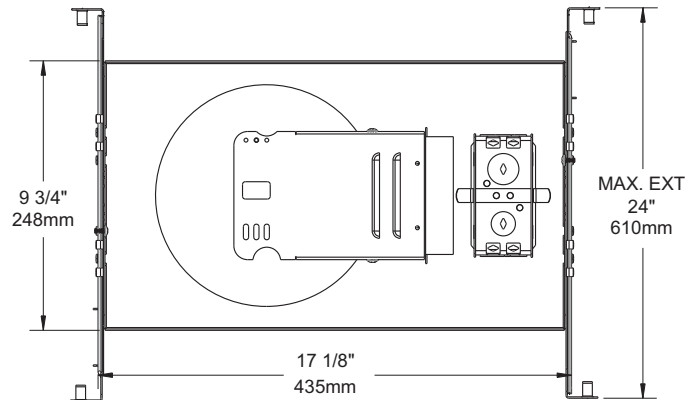
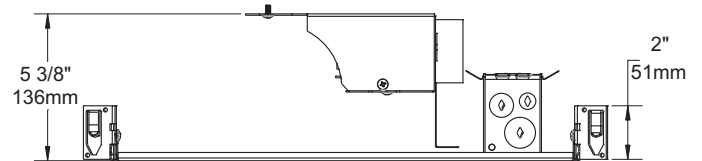
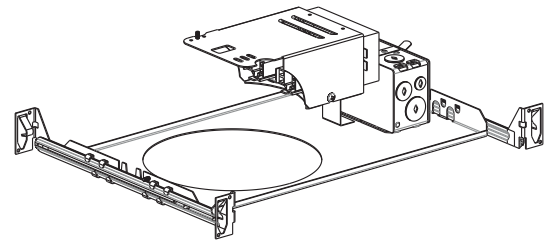

#### TECHNICAL SPECIFICATIONS

##### HOUSING FEATURES

Galvanized steel.  
Preset socket assembly and keyhole on socket assembly for easier installation.  
Below-ceiling accessible.

##### LISTINGS

UL-cUL listed for through branch wiring and damp location.

##### LOCKING SYSTEM

Perfect fit into ceiling.  
No light leak.  
Hooks PAT#CAN.2.088.648 and #USA.5.377.088  
Takes up to 7/8" thick ceiling.

##### SOCKET

High temperature-rated.  
130°C instead of 90°C.  
Stainless steel contacts.

##### BALLAST

120V/277V Class P  
HPF Electronic ballast.  
Program start without flickering 10% THD and end of life lamp protection.  
5 year warranty.

##### MOUNTING BARS

Locked into place and adjustable from 10" to 24" using the integral T-Bars tabs. May be installed in trusses or suspended ceilings.