







# SPECIFICATION SHEET

## 7" COMPACT FLUORESCENT SERIES

# NWF7

### NEW CONSTRUCTION HOUSING FOR HORIZONTAL LAMP

	<b>YES</b>		<b>E175084</b>						
	<b>ELECTRONIC BALLAST</b>								
	<b>8" (203mm)</b>								
	<b>120-277 VOLTS (CAN &amp; USA.)</b> <b>347 VOLTS (CAN)</b>								
	<b>13W, 18W or 26W</b>	<table border="0"> <tr> <td>13W : G24q-1</td> <td>4 PIN DTT</td> </tr> <tr> <td>18W : G24q-2</td> <td>4 PIN DTT</td> </tr> <tr> <td>26W : G24q-3</td> <td>4 PIN DTT</td> </tr> </table>	13W : G24q-1	4 PIN DTT	18W : G24q-2	4 PIN DTT	26W : G24q-3	4 PIN DTT	
13W : G24q-1	4 PIN DTT								
18W : G24q-2	4 PIN DTT								
26W : G24q-3	4 PIN DTT								

#### CODES :

NWF7U13	2 X 13W	G24q-1	DTT	} 120 to 277 VOLT <u>UNIVERSAL</u> BALLAST
NWF7U18	2 X 18W	G24q-2	DTT	
NWF7U26	2 X 26W	G24q-3	DTT	
NWF7313	2 X 13W	G24q-1	DTT	} 347 VOLT BALLAST (FOR CANADA ONLY)
NWF7318	2 X 18W	G24q-2	DTT	
NWF7326	2 X 26W	G24q-3	DTT	
NWF7D18	2 X 18W	G24q-2	DTT	} 120 VOLT <u>D</u> IMMABLE BALLAST
NWF7D26	2 X 26W	G24q-3	DTT	
NWF7D182	2 X 18W	G24q-2	DTT	} 277 VOLT DIMMABLE BALLAST (FOR U.S.A. ONLY)
NWF7D262	2 X 26W	G24q-3	DTT	

#### COMPATIBLE TRIMS

FR7C	FR7OLA
FR7O	FR7OLB
FR7OM	FR7T

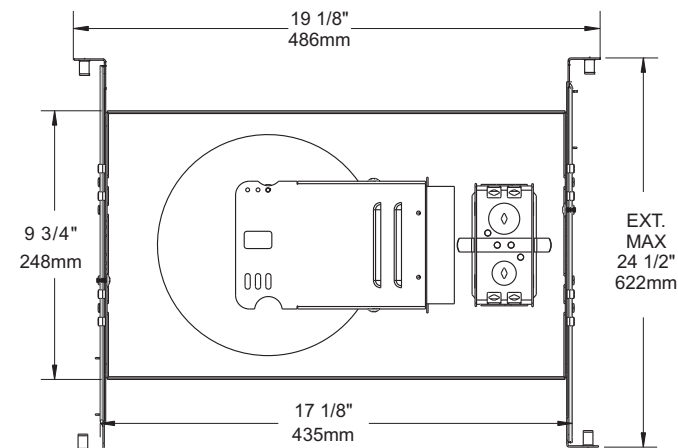
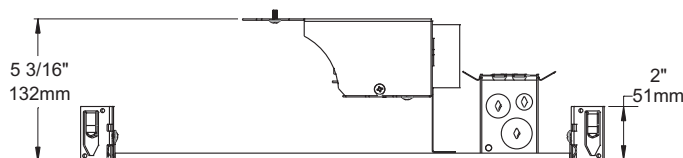
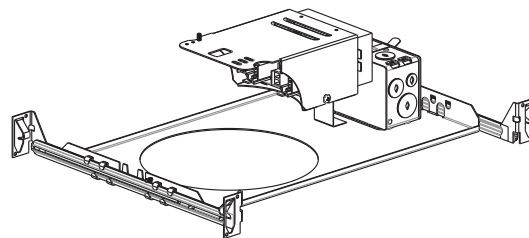

#### ENERGY STAR Requirements

120 Volt ONLY

- Lamp with a rated life of 10 000 hours or more, in these colors : 2700K, 3000K, 3500K or 4100K.

Generic lamp designation :

CFQ13W/G24q	CFQ26W/G24q
CFQ18W/G24q	CFTR26W/GX24q
CFTR18W/GX24q	CFTR32W/GX24q

Combine housing with one of the following trims :

- FR7C
- FR7O
- FR7OM
- FR7OLA
- FR7OLB
- FR7T



#### TECHNICAL SPECIFICATIONS

##### HOUSING FEATURES

Galvanized steel.  
Preset socket assembly and keyhole on socket assembly for easier installation.  
Below-ceiling accessible.

##### LISTINGS

UL-cUL listed for through branch wiring and damp location.

##### LOCKING SYSTEM

Perfect fit into ceiling.  
No light leak.  
Hooks PAT#CAN.2.088.648 and #USA.5.377.088  
Takes up to 7/8" thick ceiling.

##### SOCKET

High temperature-rated.  
130°C instead of 90°C.  
Stainless steel contacts.

##### BALLAST

120V/277V Class P  
HPF Electronic ballast.  
Program start without flickering 10% THD and end of life lamp protection.  
5 year warranty.

**CONTRAST**  
LIGHTING

1009, rue du Parc Industriel, Saint-Jean-Chrysostome, Qc, CAN G6Z 1C5 TEL.:1-888-839-4624 Fax : 1-877-839-7057  
info@contrastlighting.com  
www.contrastlighting.com

JUNE 2010