





SPECIFICATION SHEET

4" FLUORESCENT COMPACT SERIES

NWF2000LU

NEW CONSTRUCTION HOUSING FOR VERTICAL LAMP

	YES
Damp Location	
	ELECTRONIC BALLAST
Voltage	120 VOLTS (CAN & USA.) 277 VOLTS (USA) 347 VOLTS (CAN)
	4 1/4" (107mm)
OD Cut	
	E175084
Compact Fluorescent	18W, 26W OR 32W <ul style="list-style-type: none"> 18W : GX24q-2 4 PIN TTT 26W : GX24q-3 4 PIN TTT 32W : GX24q-3 4 PIN TTT

CODES :

NWF2000LU18	} 120 TO 277 VOLT <u>UNIVERSAL</u> BALLAST
NWF2000LU26	
NWF2000LU32	
NWF2000L318	} <u>347 VOLT</u> BALLAST FOR CANADA ONLY
NWF2000L326	
NWF2000L332	
NWF2000LD18	} 120 VOLT BALLAST
NWF2000LD26	
NWF2000LD32	
NWF2000LD182	} 277 VOLT <u>DIMMABLE</u> BALLAST FOR UNITED-STATES ONLY
NWF2000LD262	
NWF2000LD322	

COMPATIBLE TRIMS

18W ou 26W	18W, 26W ou 32W
A2400S	A2000V
A2401S	A2000VL
A2450S	A2000VS
A2451S	A2000VLS
	F2450VT



ENERGY STAR Requirements

120 Volt ONLY

- Lamp with a rated life of 10 000 hours or more, in these colors : 2700K, 3000K, 3500K or 4100K.
Generic lamp designation :
- CFTR18W/GX24q
- CFTR26W/GX24q
- Combine housing with one of the following trims :
A2000V / A2010V
A2000VL / A2010VL
A2000VS / A2010VS
A2000VLS / 2010VLS
A2400S / 2401S
A2450S / 2451S
F2450VT

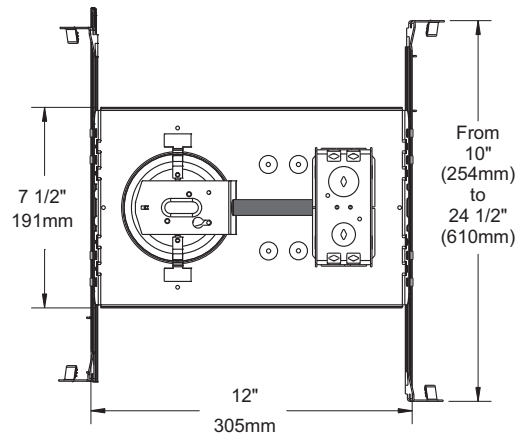
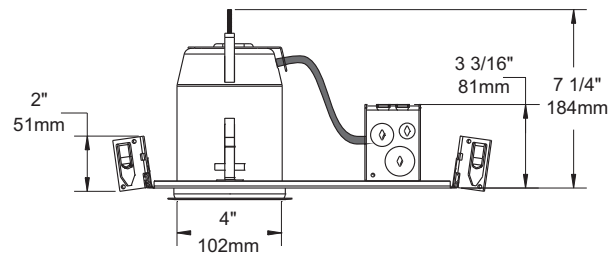
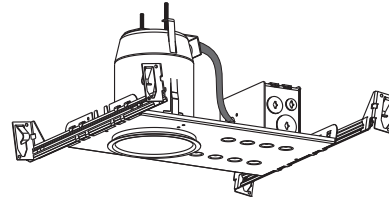

MADE IN CANADA



Certified UL Standards

TECHNICAL SPECIFICATIONS

HOUSING FEATURES

Galvanized steel.
Preset socket assembly and keyhole on socket assembly for easier installation.
Below-ceiling accessible.

LISTINGS

UL-cUL listed for through branch wiring and damp location.

LOCKING SYSTEM

Perfect fit into ceiling.
No light leak.
Hooks PAT#CAN.2.088.648 and #USA.5.377.088
Takes up to 7/8" thick ceiling.

SOCKET

High temperature-rated.
130°C instead of 90°C.
Stainless steel contacts.

MOUNTING BARS

Locked into place and adjustable from 10" to 24" using the integral T-Bars tabs. May be installed in trusses or suspended ceilings.

BALLAST

120V/277V Class P HPF Electronic ballast.
Program start without flickering 10% THD and end of life lamp protection.
5 year warranty.

CONTRAST
LIGHTING

1009, rue du Parc Industriel, Saint-Jean-Chrysostome, Qc, CAN G6Z 1C5 Tel.: 1-888-839-4624 Fax : 1-877-839-7057
info@contrastlighting.com
www.contrastlighting.com

MAI 2010