

**SPECIFICATION SHEET**

**PROJECT No:**  
\_\_\_\_\_

**"NON-IC" TYPE HOUSING**

**NW4000M**

120/12V

-  **yes**

---

- VOLTAGE** **120 VOLTS**

---

-  **12 V 35W max.**

---

- 

---

- 

---

- 

---

-  **EC 35M 35 VA 120V / 12V**

---

-  **T°C 120°C No 031**

---

- Double top

---

- UL number : **E 174023**

---

- E Electronic M Magnetic C Short L Long**

**TRIMS AVAILABLE**  
T4000, T4200, T4200V, T4210V, T4230V, T4300

 **OD Cut : 3 1/4" (82 mm)**

NOTES:  
For accessible ceiling without insulation  
50W Magnetic transformer  
available in 277/12V and 347/12V

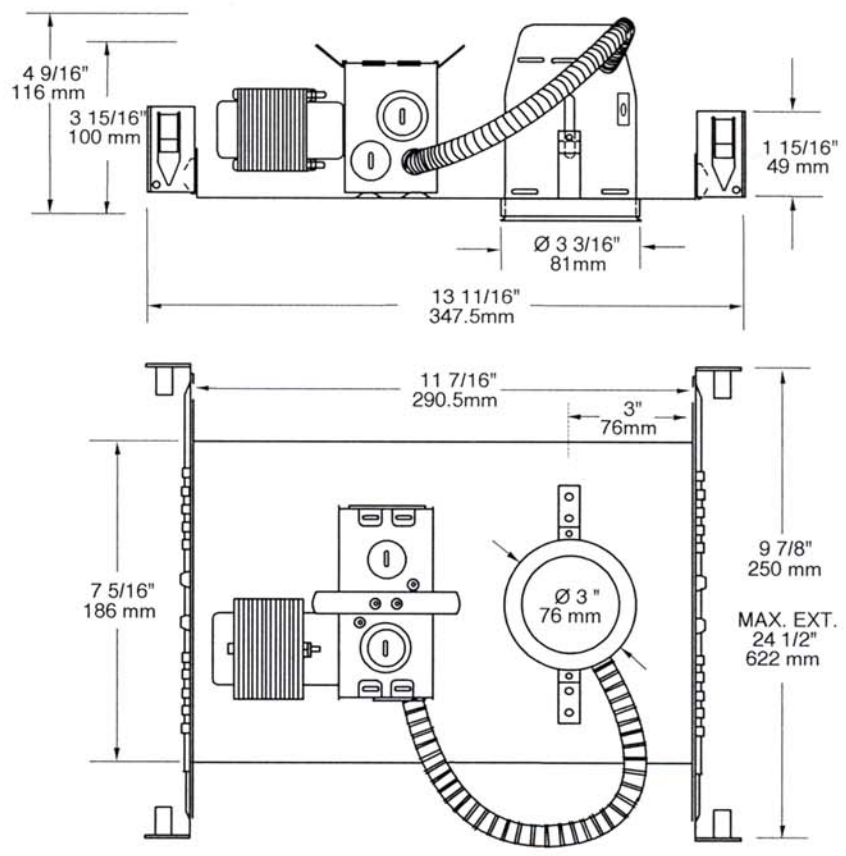

Your Project: \_\_\_\_\_  
\_\_\_\_\_  
\_\_\_\_\_

Representative: \_\_\_\_\_

