

SPECIFICATION SHEET

PROJECT No:

"NON-IC" TYPE HOUSING

NW4000E 120/12V

-  **yes**

- VOLTAGE** **120 VOLTS**

-  **12 V 35W max.**

-  _____

-  _____

-  _____

-  **Electronic Transformer**
120V / 12V

-  **T°C 120°C No 031**

- Double top**

UL number : **E 174023**

E Electronic **M** Magnetic **C** Short **L** Long

AVAILABLE TRIMS
 T4000, T4200, T4210V, T4300

 **OD Cut : 3 5/16" (84 mm)**

NOTES:
 For ceiling without insulation
 Below ceiling access

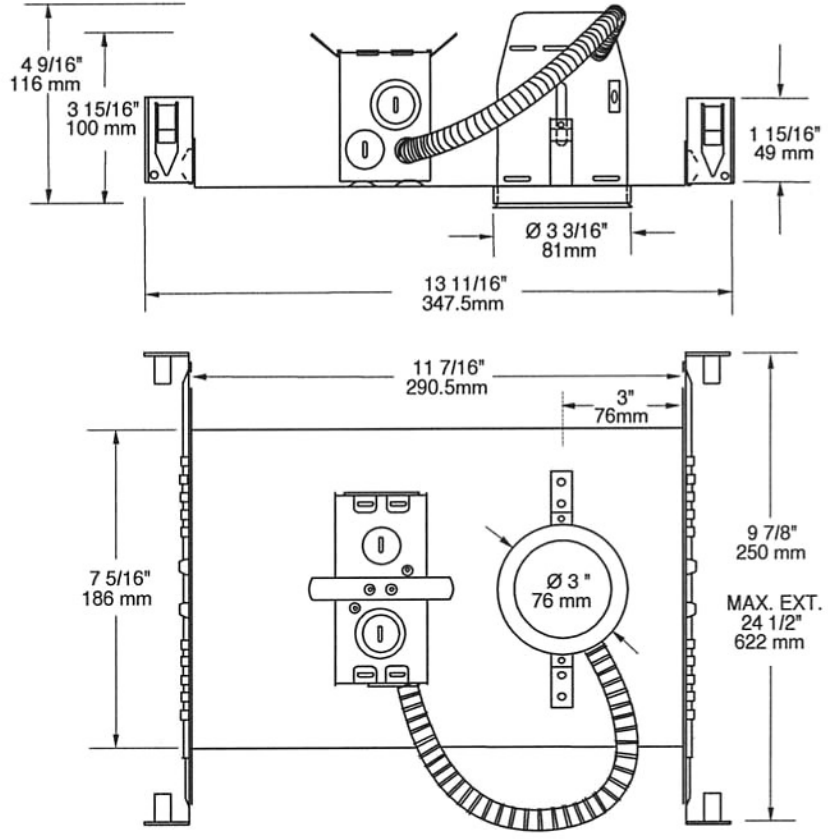

PROJECT

Your Project: _____

Representative: _____