









"NON-IC" TYPE HOUSING
NW3600CA

-  _____
- yes** _____
-  **VOLTAGE** **120 VOLTS** _____
-  _____
-  **PAR20 50W max.** _____
-  _____
-  **T°C 120°C No 031** _____
-  **Double top** _____
- UL number : E 174023** _____
- E Electronic M Magnetic C Short L Long** _____

 **OD Cut : 3 3/4" (95 mm)**

NOTES:
 For ceiling without insulation
 Below ceiling access

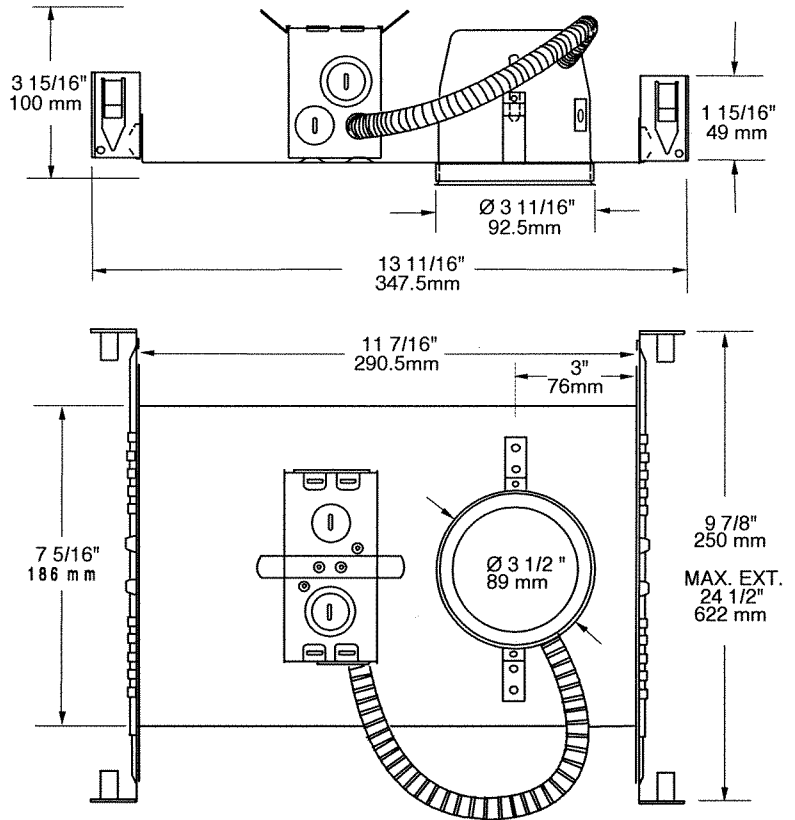

PROJECT

Your Project: _____

Representative: _____