









SPECIFICATION SHEET

PROJECT No:

"NON-IC" TYPE HOUSING

NW2000T

-  _____
yes
-  **VOLTAGE** _____
120 VOLTS
-  _____
GU / GZ-10 50W
-  _____
-  _____
-  _____
T°C 120°C No 031
-  _____
Double top
-  _____
UL number : **E 174023**
-  _____
E Electronic **M** Magnetic **C** Short **L** Long

 **OD Cut : 4 1/4" (107 mm)**

NOTES:
For ceiling without insulation
Below ceiling access

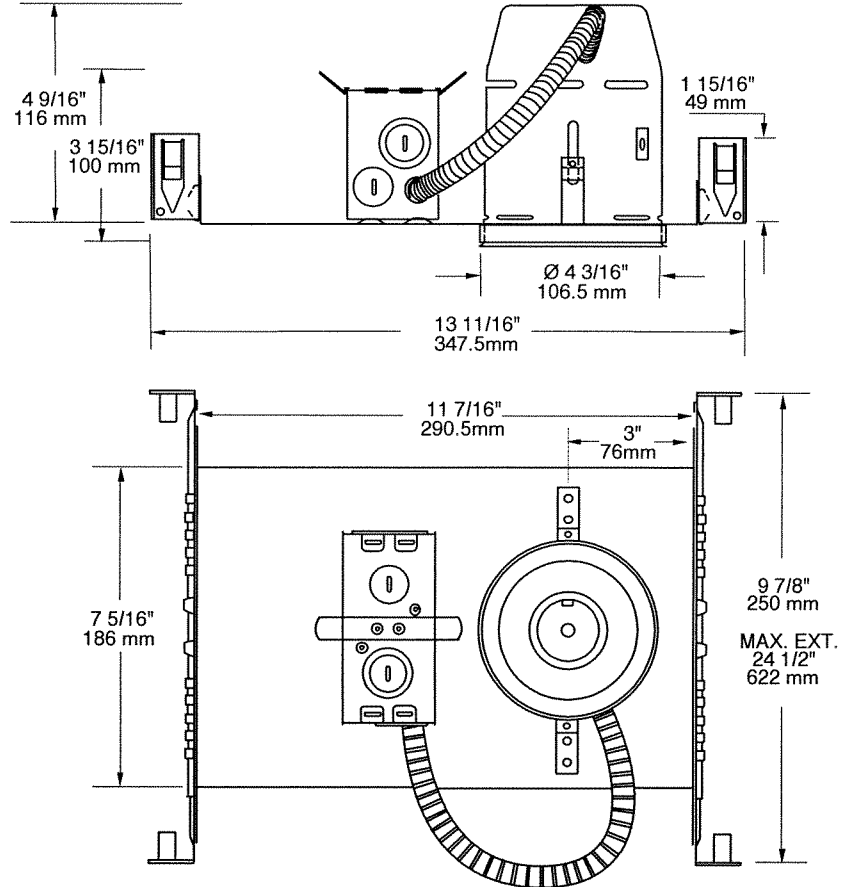

PROJECT

Your Project: _____

Representative: _____