

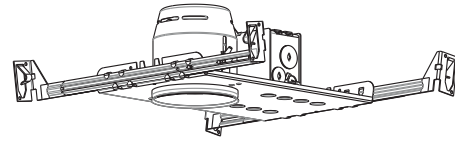







SPECIFICATION SHEET

4" 2000 SERIES

NW2000E



SHALLOW NEW CONSTRUCTION HOUSING
WITH ELECTRONIC CONVERTER

	YES
Damp Location	
	MR16 50W MAX
MR16	
	NW2000E : 120 VOLTS (CAN & USA.) NW2000E2 : 277 VOLTS (USA ONLY)
Voltage	
	Electronic Converter 120V / 12V Electronic Converter 277V / 12V
Electronic Converter	
	T°C 120°C No 031
Thermal Protector	
	4 1/4" (108mm)
OD Cut	
	E174023
UL LISTED	
	Overall Dimensions : Length : 14 1/2" (368mm) Width : 7 1/2" (190mm) Height : 4" (101mm)
Dimensions	

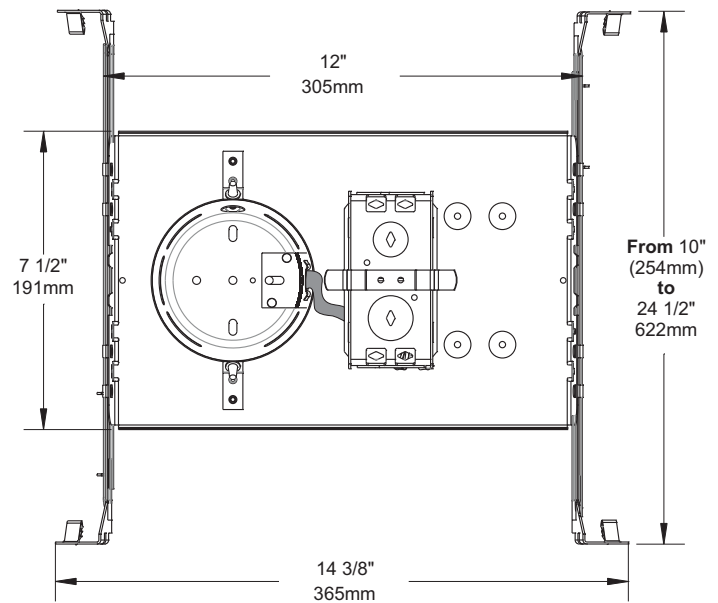
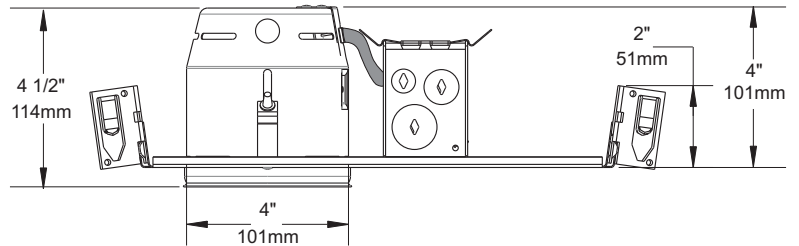

COMPATIBLE TRIMS

50W MR16

R2000	R2100VSM/ST	T2000
R2000VSM/ST	R2110VSM/ST	T2000V (T2010V)
R2010VSM/ST	R2130VSM/ST	T2000VL (T2010VL)
R2030VSM/ST	R2120	T2000VS (T2010VS)
R2020	R2450VT	T2000VLS T2010VLS)
R2051	S2000	
R2100	S2051	
R2100VT	S2100	

TECHNICAL SPECIFICATIONS

0,051" (1,3mm) thickness Galvanized Steel.
Below-ceiling accessible.
Hooks PAT#CAN 2,088,648 and #USA 5,377,088.
Takes up to 7/8" thick ceiling.
Perfect fit into ceiling.
No light leak.
Each part of the case should be at 3 "(76mm) MINIMUM from insulation (if applicable).



Your representative : _____

Your project : _____