





**"NON-IC" TYPE HOUSING**  
**NW2000CAD**

-   **yes**



---

- VOLTAGE** **120 VOLTS**

---

- 
- 
-   **PAR20 50W max.**

---

- 
- 
- T°C 100°C No 027**

---

- Double top**

---

- UL number :** **E 174023**

---

- E** Electronic **M** Magnetic **C** Short **L** Long

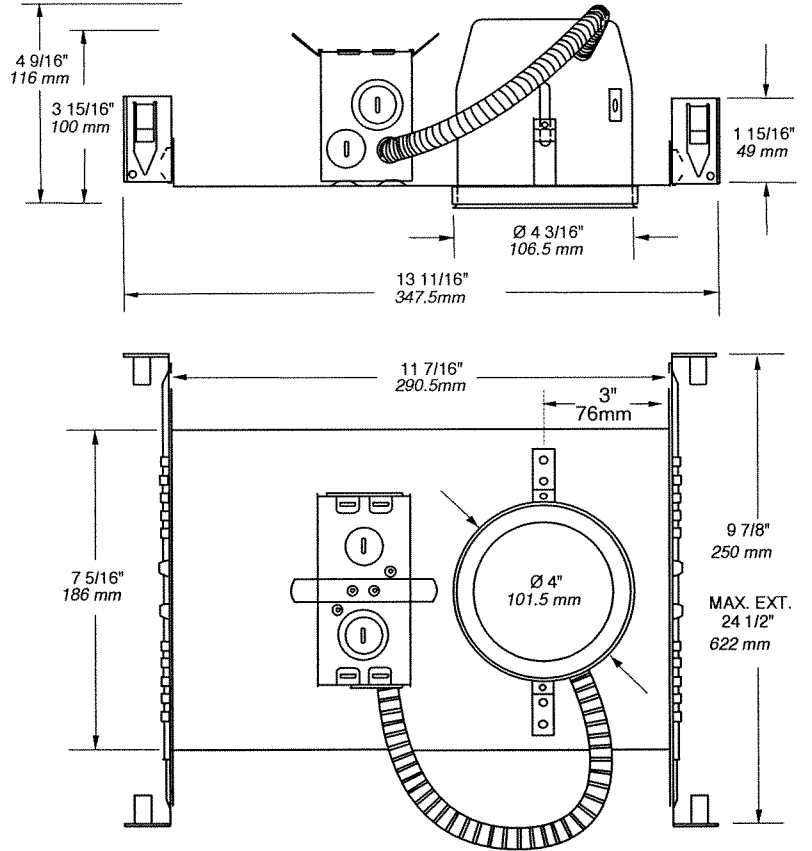

 **OD Cut : 4 1/4" (107 mm)**

**NOTES:**  
 For ceiling without insulation  
 Below ceiling access



**PROJECT**

Your Project: \_\_\_\_\_  
 \_\_\_\_\_  
 \_\_\_\_\_

Representative: \_\_\_\_\_