







**"NON-IC" TYPE HOUSING  
NW2000CA**

	<b>yes</b>
<b>VOLTAGE</b>	<b>120 VOLTS</b>
	
	
	<b>PAR20 50W max.</b>
	
	
	<b>T°C 100°C No 027</b>
<b>Double top</b>	
<b>UL number :</b>	<b>E 174023</b>
<b>E</b> Electronic <b>M</b> Magnetic <b>C</b> Short <b>L</b> Long	

**TRIMS AVAILABLE**  
A2000, A2000V, A2010V, A2030V  
A2000VL, A2010VL, A2030VL

 **OD Cut : 4 1/4" (107 mm)**

**NOTES:**  
For ceiling without insulation  
Below ceiling access

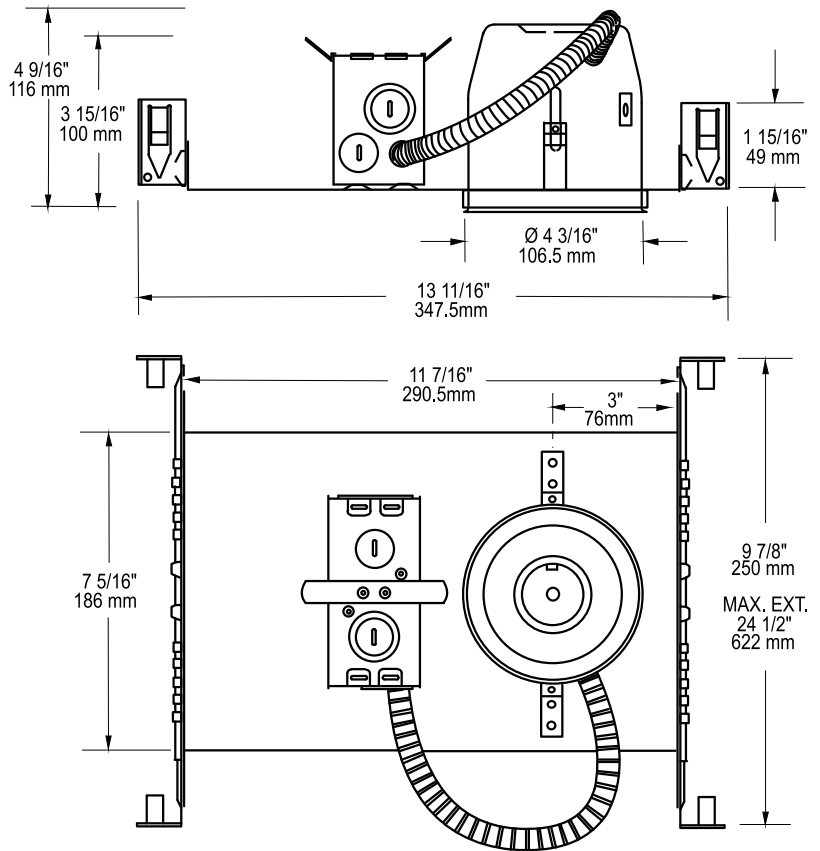

Certified UL Standards

**PROJECT**

Your Project: \_\_\_\_\_

Representative: \_\_\_\_\_