









# SPECIFICATION SHEET

3" 4000 SERIES

## IT4000M IT4000M2 IT4000M3

REMODEL HOUSING WITH  
MAGNETIC TRANSFORMER

	YES
	MR16 35W MAX
	Magnetic Transformer 120V/12V Magnetic Transformer 277V/12V Magnetic Transformer 347V/12V
	IT4000CM : 120 VOLTS (CAN & USA) IT4000CM2 : 277 VOLTS (USA) IT4000CM3 : 347 VOLTS (CAN)
	T°C 105°C No 029
	3 1/4" (82mm)
	E174023
	Overall Dimensions : Length : 13" (330mm) Width : 4 1/4" (108mm) Height : 6" (152mm)

### COMPATIBLE TRIMS

MR16 35W	MR16 20W
T4000	S4151
T4125	S4450
T4200	T4145
T4200V	T4450
T4210V	T4650
T4300	

### TECHNICAL SPECIFICATIONS

0,021" (0,53mm) thickness Galvanized Steel.  
Below-ceiling accessible.  
Hooks PAT#CAN 2,088,648 and #USA 5,377,088.  
Takes up to 7/8" thick ceiling.  
Perfect fit into ceiling.  
No light leak.

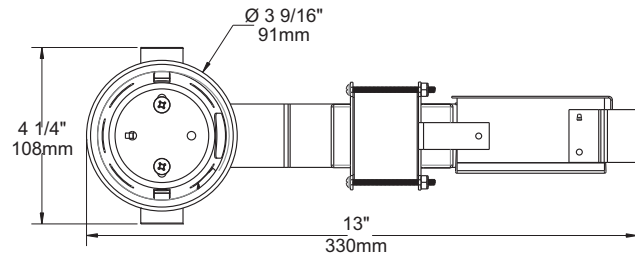
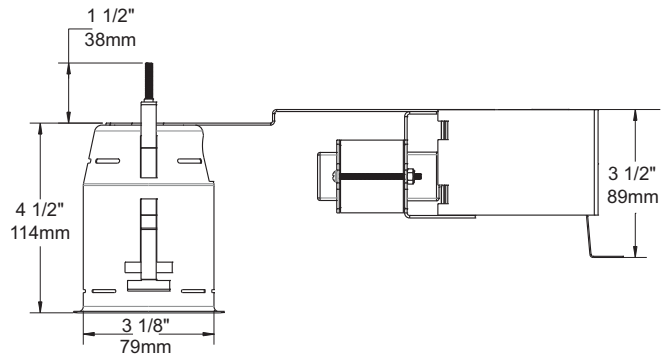
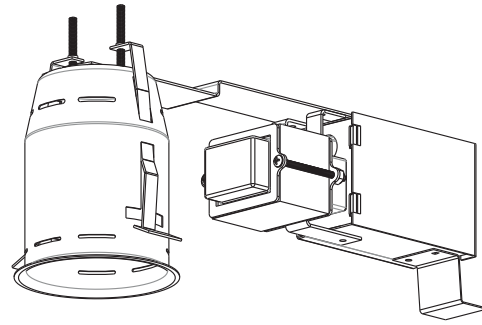

Your representative : \_\_\_\_\_

Your project : \_\_\_\_\_

\_\_\_\_\_

\_\_\_\_\_

