









**"NON-IC" TYPE HOUSING**

IT4000E

	<b>yes</b>
<b>VOLTAGE</b>	<b>120 VOLTS</b>
	<b>12 V 35W max.</b>
	
	
	
	<b>ELEC. CONV. 120V/12V</b>
	<b>T°C 120°C No 031</b>
<b>BX Length</b>	<b>5" (127 mm)</b>
<b>UL number</b>	<b>E 174023</b>
<b>E</b> Electronic <b>M</b> Magnetic <b>C</b> Short <b>L</b> Long	

 **OD Cut : 3 1/4" (83 mm)**

NOTES:  
For ceiling without insulation  
Below ceiling access

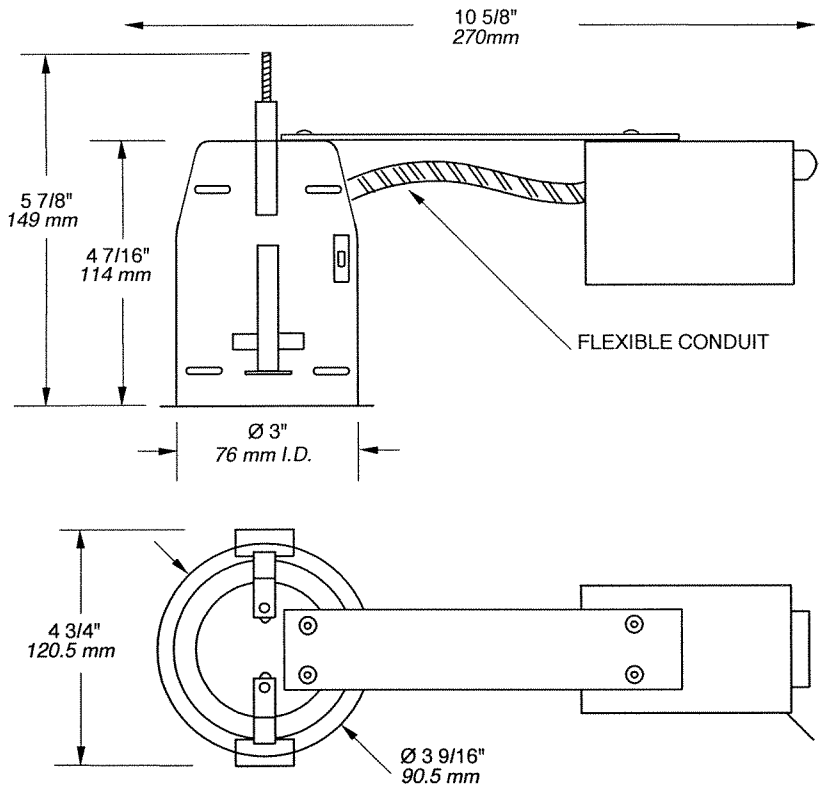

**PROJECT**

Your Project: \_\_\_\_\_

\_\_\_\_\_

\_\_\_\_\_

Representative: \_\_\_\_\_