









SPECIFICATION SHEET

PROJECT No:

"NON-IC" TYPE HOUSING

IT4000CM

	yes
VOLTAGE	120, 277 or 347 VOLTS
	12 V 20W max.
	
	
	
	EC20M 20 VA 120V / 12V
	
	T°C 95°C No 026
BX Length	7" (177 mm)
UL number	E 174023
E Electronic M Magnetic C Short L Long	

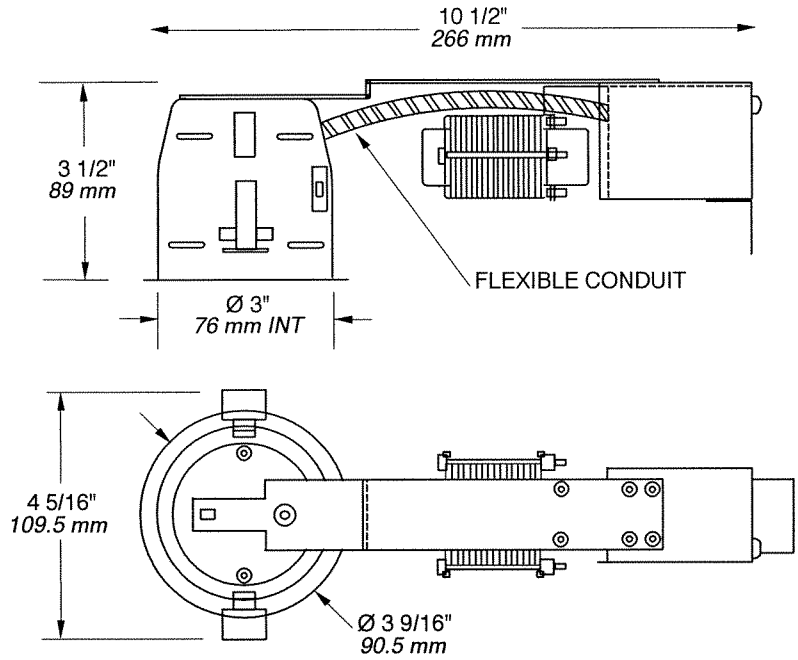

 **OD Cut : 3 1/4" (83 mm)**

NOTES:
For ceiling without insulation
Below ceiling access



PROJECT

Your Project: _____

Representative: _____