











SPECIFICATION SHEET

PROJECT No:

"NON-IC" TYPE HOUSING
IT4000CE

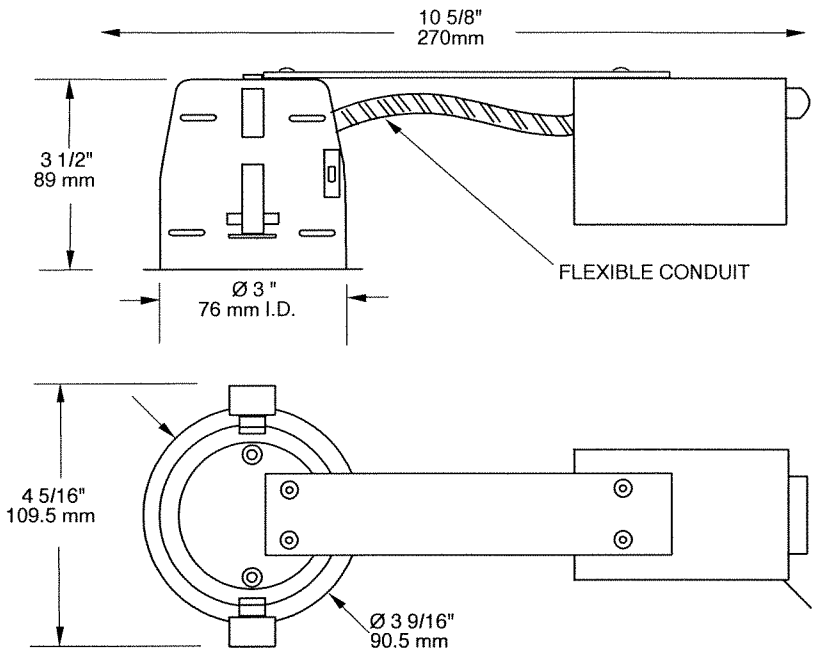
	yes
VOLTAGE	120 VOLTS
	12 V 20W max.
	
	
	
	
	ELEC. CONV. 120V/12V
	T°C 95°C No 026
BX Length	5" (127 mm)
UL number	E 174023
E Electronic M Magnetic C Short L Long	



 **OD Cut : 3 1/4" (83 mm)**

NOTES:
 For ceiling without insulation
 Below ceiling access



PROJECT

Your Project: _____

Representative: _____