









SPECIFICATION SHEET

3 1/2" 3000 SERIES

IT3000M IT3000M2 IT3000M3

REMODEL HOUSING WITH
MAGNETIC TRANSFORMER

	YES
Damp Location	
	MR16 42W MAX
MR16	
	IT3000M : 120 VOLTS (CAN & USA.) IT3000M2 : 277 VOLTS (USA) IT3000M3 : 347 VOLTS (CANADA)
Voltage	
	Magnetic Transformer EC50M 50 VA 120V / 12V EC50M2 50 VA 277V / 12V EC50M3 50 VA 347V / 12V
	T°C 120°C No 031
Thermal Protector	
	3 5/8" (92mm)
OD Cut	
	E174023
UL LISTED	
	Overall Dimensions : Length : 13 5/16" (338mm) Width : 4 5/8" (118mm) Height : 6" (152mm)
Dimensions	

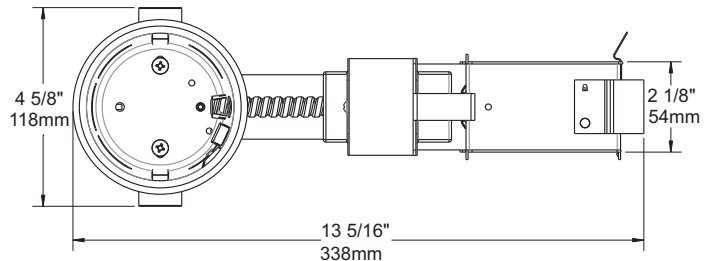
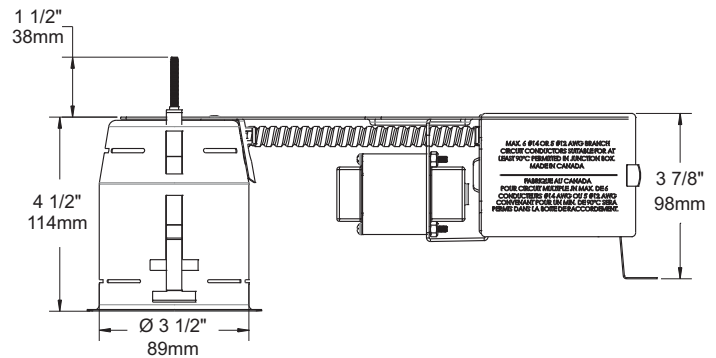
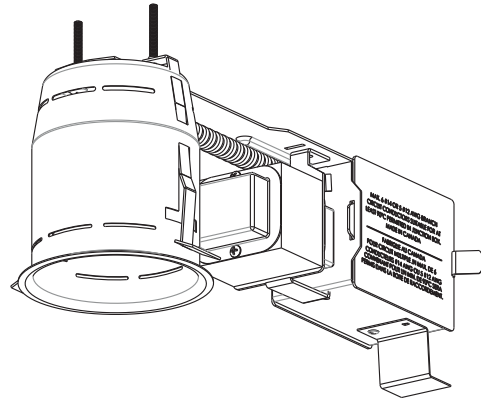

COMPATIBLE TRIMS

42W MR16

T3000	T3200	T3400D
T3100	T3250	T3450
T3125	T3260	T3450D
T3145	T3300	T3500
T3145D	T3400	T3500D

TECHNICAL SPECIFICATIONS

0,051" (1,3mm) thickness Galvanized Steel.
Below-ceiling accessible.
Hooks PAT#CAN 2,088,648 and #USA 5,377,088.
Takes up to 7/8" thick ceiling.
Perfect fit into ceiling.
No light leak.
Each part of the case should be at 3 "(76mm) MINIMUM from insulation (if applicable).



Your representative : _____

Your project : _____