









# SPECIFICATION SHEET

3 1/2" 3000 SERIES

## IT3000LM IT3000LM2 IT3000LM3

LONG REMODEL HOUSING WITH  
MAGNETIC TRANSFORMER

	<b>YES</b>
<b>Damp Location</b>	
	<b>MR16 50W MAX</b>
<b>MR16</b>	
	<b>IT3000LM : 120 VOLTS (CAN &amp; USA.) IT3000LM2 : 277 VOLTS (USA) IT3000LM3 : 347 VOLTS (CANADA)</b>
<b>Voltage</b>	
	<b>Magnetic Transformer EC50M 50 VA 120V / 12V EC50M2 50 VA 277V / 12V EC50M3 50 VA 347V / 12V</b>
<b>Magnetic Transformer</b>	
	<b>T°C 125°C No 031</b>
<b>Thermal Protector</b>	
	<b>3 5/8" (92mm)</b>
<b>OD Cut</b>	
	<b>E174023</b>
<b>UL US LISTED</b>	
	<b>Overall Dimensions :</b> Length : 13 7/16" (341mm) Width : 4 1/2" (114mm) Height : 7 1/8" (181mm)
<b>Dimensions</b>	

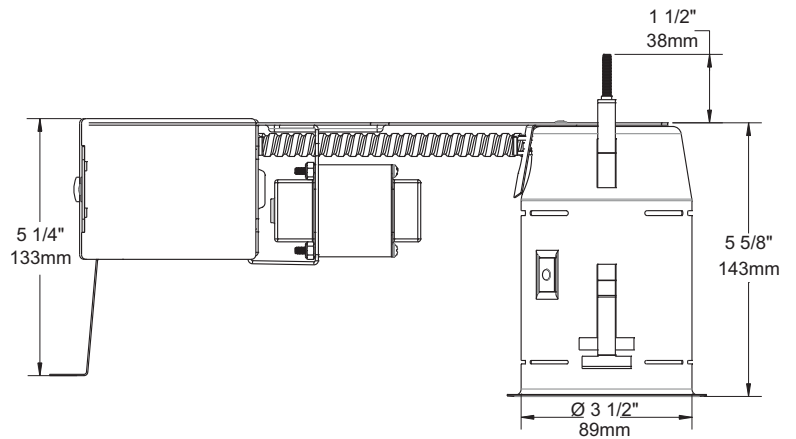
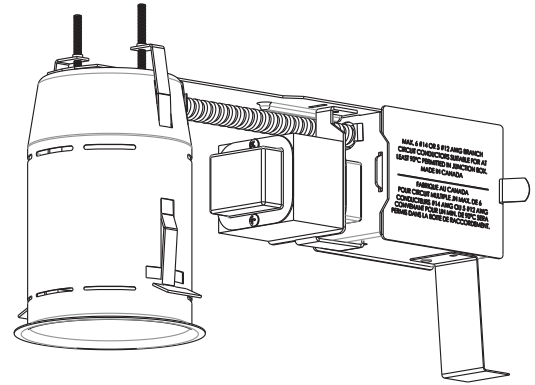

### COMPATIBLE TRIMS

#### 50W MR16

R3151	S3450	T3185	T3500D
R3151W	S3500	T3200	T3500W
R3152	S3601	T3250	T3600
R3601	S3651	T3260	T3602
R3601W	T3000	T3300	T3650
R3602	T3100	T3400	T3652
R3651	T3125	T3400D	T3700
R3651W	T3145	T3400W	T3800
R3652	T3145D	T3450	T3850
S3145	T3145W	T3450D	T3900
S3151	T3152	T3450W	
S3400	T3165	T3500	

#### 42W MR16

S3145D
S3400D
S3450D
S3500D

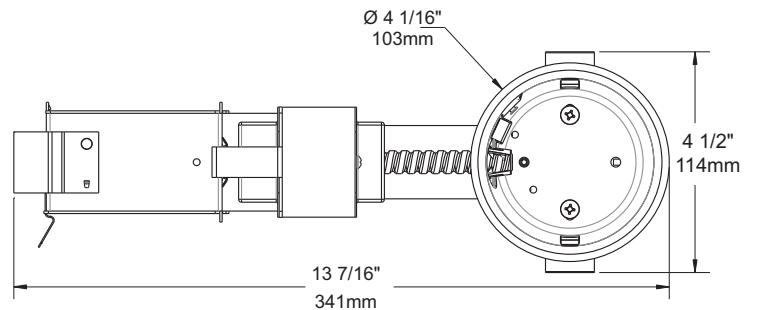

### TECHNICAL SPECIFICATIONS

0,051" (1,3mm) thickness Galvanized Steel.  
Below-ceiling accessible.  
Hooks PAT#CAN 2,088,648 and #USA 5,377,088.  
Takes up to 7/8" thick ceiling.  
Perfect fit into ceiling.  
No light leak.  
Each part of the case should be at 3 "(76mm) MINIMUM from insulation (if applicable).



Your representative : \_\_\_\_\_

Your project : \_\_\_\_\_