









SPECIFICATION SHEET

PROJECT No:

"NON-IC" TYPE HOUSING

IT3000CM 120/12V
 IT3000CM2 277/12V
 IT3000CM3 347/12V

	yes
VOLTAGE	120, 277 or 347 VOLTS
	12 V 35W max.
	
	
	EC50M 50 VA 120V / 12V
	EC50M2 50 VA 277V / 12V
	EC50M3 50 VA 347V / 12V
	
	T°C 120°C No 031
BX Length	6 1/2" (165 mm)
UL number	E 174023
E Electronic M Magnetic C Short L Long	

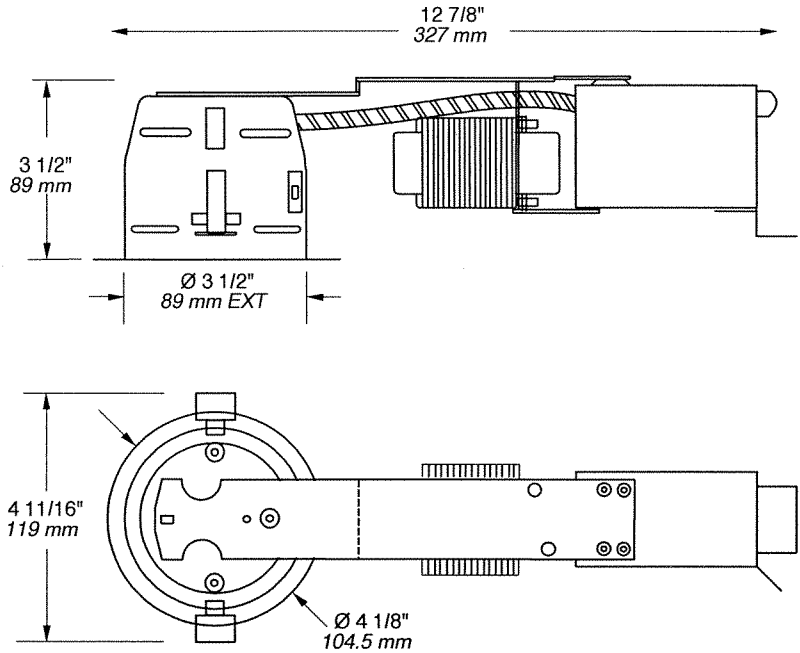

 OD Cut : 3 5/8" (92 mm)

NOTES:
 For ceiling without insulation
 Below ceiling access
 Magnetic transformer available in 277/12V
 and 347/12V



PROJECT

Your Project: _____

Representative: _____