







SPECIFICATION SHEET

3 1/2" 3000 SERIES

IT3000CE IT3000CE2

SHALLOW REMODEL HOUSING WITH ELECTRONIC CONVERTER

	YES
	MR16 37W MAX
	IT3000CE : 120 VOLTS (CAN & USA.) IT3000CE2 : 277 VOLTS (USA)
	Electronic Converter IT3000CE : 120V / 12V Converter IT3000CE2 : 277V / 12V Converter
	T°C 110°C No 029
	3 5/8" (92mm)
	E174023

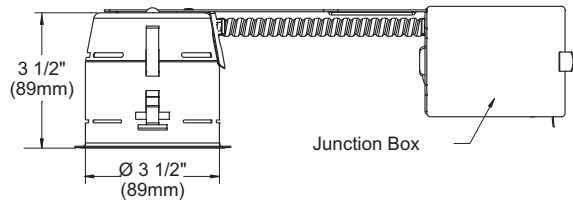
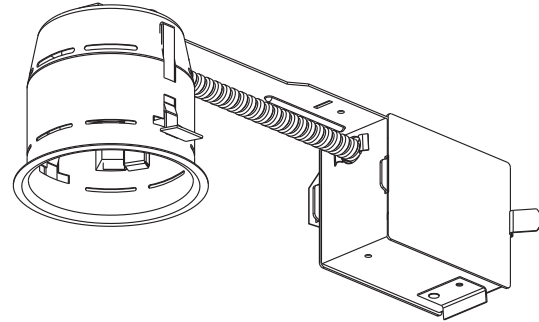

COMPATIBLE TRIMS

35W MR16			37W MR16	
T3000	T3250	T3400D	R3450D	T3145DG
T3100	T3260	T3450D	R3470	T3250DG
T3125	T3300	T3500D	R3470D	
T3200				

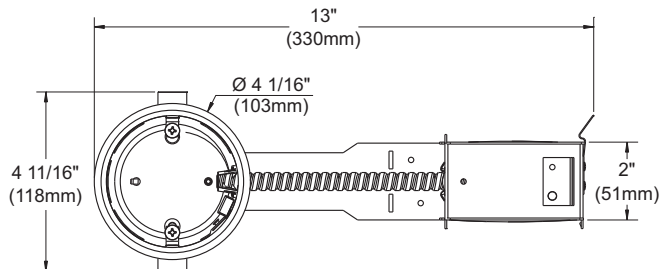

TECHNICAL SPECIFICATIONS

Galvanized steel
 Below-ceiling accessible
 Hooks PAT#CAN.2.088.648 and #USA.5.377.088
 Takes up to 7/8" thick ceiling
 Perfect fit into ceiling
 No light leak
 Each part of the case should be at 3 "(76mm) MINIMUM from insulation (if applicable).



Your representative : _____

Your project : _____

CONTRAST
L I G H T I N G

1009, rue du Parc Industriel, Saint-Jean-Chrysostome, Qc, CAN, G6Z1C5 Tel.: 1-888-839-4624 Fax : 1-877-839-7057
info@contrastlighting.com
www.contrastlighting.com

FEBRUARY 2011