







SPECIFICATION SHEET

"IC" TYPE HOUSING

ISF2675R

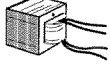
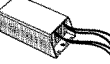
PROJECT No:

	_____
Voltage	yes
	120 VOLTS
	_____
	_____
	1 x13W GX23-2 2PIN DTT
	H.P.F. Magnetic Ballast
	_____
	_____
Double top	no
UL number	E 175084
E Electronic M Magnetic C Short L Long	
AIR TIGHT HOUSING	

AVAILABLE TRIMS
B2675

 **OD Cut : 4 5/8" (118 mm)**

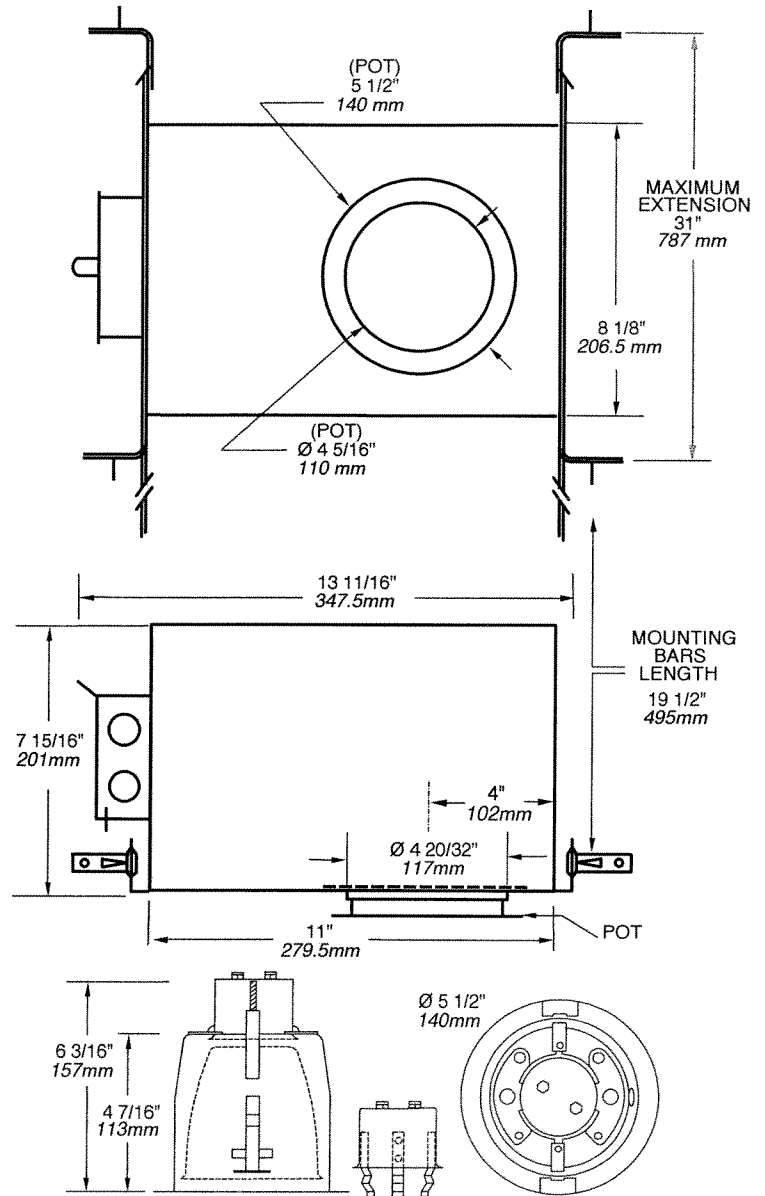

TECHNICAL SPECIFICATIONS

<p>HOUSING FEATURES Galvanized steel Preset socket assembly and Keyhole on socket assembly for easier installation Below ceiling accessible See specs housing section</p>	<p>LOCKING SYSTEM Perfect fit to ceiling No light leak Hooks PAT#CAN.2.088.648 and #USA.5.377.088 Take up to 7/8" thick ceilings</p>	<p>MOUNTING BARS Adjustable and lockable from 10" to 24" lockable integral T-Bar tabs May be hung from trusses or suspended ceilings</p>	<p>BALLAST 120V Class P HPF Magnetic ballast instant start 2 Year Warranty</p> <p>SOCKET High temperature-rated 130° C instead of 90° C Stainless Steel contacts</p>	<p>LISTINGS UL-cUL Listed for through branch wiring and damp location</p> <p>For IC Type Housing Comply with Washington States (ASTM#E283) Energy code</p>
--	---	---	--	---

Your Project: _____

Representative: _____



CONTRAST
LIGHTING

1009, rue du Parc Industriel. Saint-Jean-Chrysostome, Quebec. CANADA G6Z 1C5 Tel.: (418) 839-4624
Toll free fax : 1-877-839-7057 Email : info@contrastlighting.com Website : www.contrastlighting.com

01 2007