







SPECIFICATION SHEET

"IC" TYPE HOUSING

ISF2000

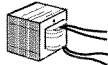
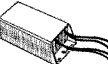
PROJECT No: _____

	_____
Voltage	120 VOLTS
	_____
	_____
	_____
	1 x13W GX23-2 2PIN DTT
	H.P.F. Magnetic Ballast
	_____
	no
Double top	no
UL number	E 175084

E Electronic M Magnetic C Short L Long

AIR TIGHT HOUSING

AVAILABLE TRIMS A2000V, A2000VL, A2000VLS, A2000VS A2010V, A2010VL, A2010VLS, A2010VS
--

 OD Cut : 4 1/4" (107 mm)

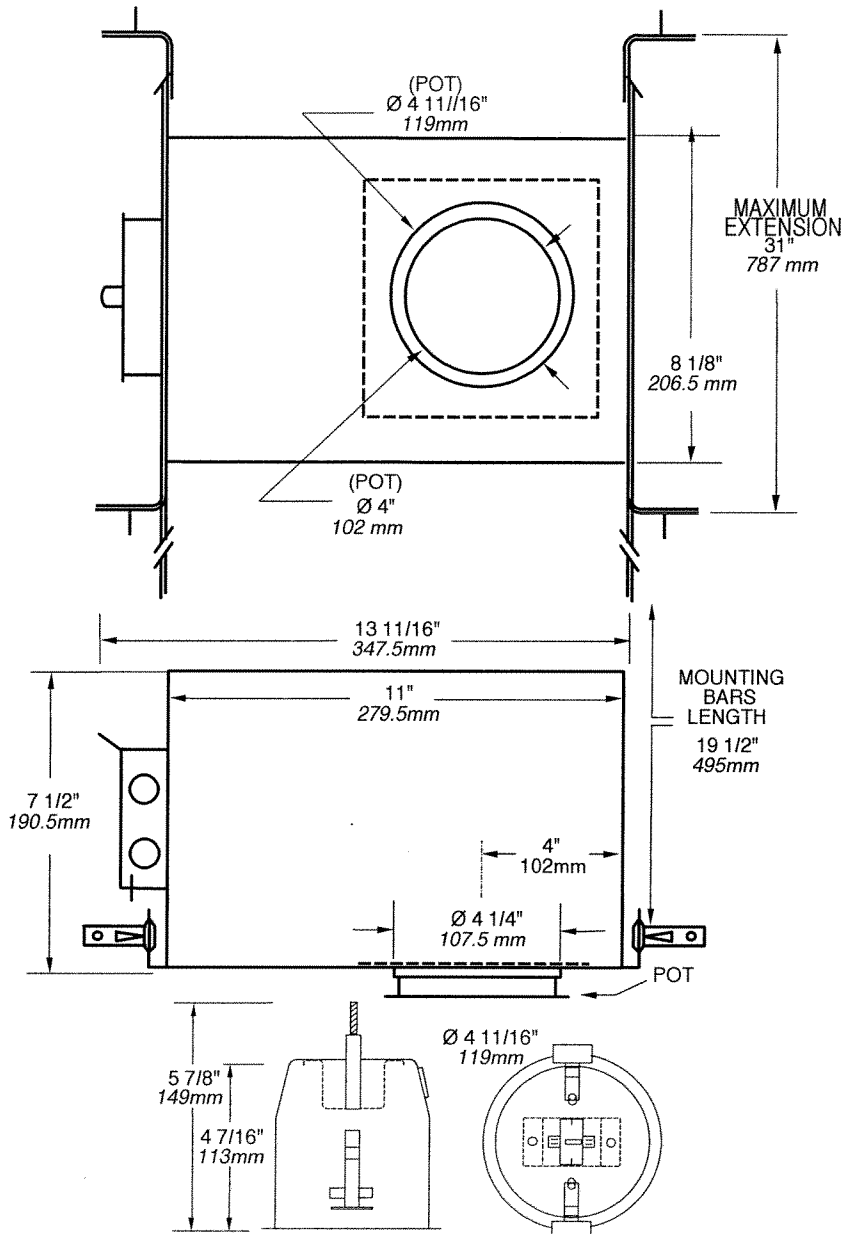

TECHNICAL SPECIFICATIONS

HOUSING FEATURES

Galvanized steel
Preset socket assembly and
Keyhole on socket assembly
for easier installation
Below ceiling accessible
See specs housing section

LOCKING SYSTEM

Perfect fit to ceiling
No light leak
Hooks PAT#CAN.2.088.648
and #USA.5.377.088
Take up to 7/8" thick ceilings

MOUNTING BARS

Adjustable and lockable
from 10" to 24" lockable
integral T-Bar tabs
May be hung from trusses
or suspended ceilings

SOCKET

High temperature-rated
130° C instead of 90° C
Stainless Steel contacts

BALLAST

120V Class P HPF Magne-
tic ballast instant start
2 Year Warranty

LISTINGS

UL-cUL Listed for through
branch wiring and damp location

For IC Type Housing
Comply with Washington States
(ASTM#E283) Energy code

Your Project: _____

Representative: _____



CONTRAST
L I G H T I N G

1009, rue du Parc Industriel. Saint-Jean-Chrysostome, Quebec. CANADA G6Z 1C5 Tel.: (418) 839-4624
Toll free fax : 1-877-839-7057 Email : info@contrastlighting.com Website : www.contrastlighting.com

01 2007