









**SPECIFICATION SHEET**

**PROJECT No:**

"NON-IC" TYPE HOUSING

**F8U26 - F8U32 - F8U42**  
**F8326 - F8332 - F8342**

-  \_\_\_\_\_  
**yes**
- VOLTAGE** 120 / 277 / 347 VOLTS
-  \_\_\_\_\_
-  \_\_\_\_\_
-  \_\_\_\_\_
-  **2 X 26W 4PIN DTT**
-  **2 X 32W 4PIN TTT**
-  **2 X 42W 4PIN TTT**
-  **Electronic Ballast**
-  \_\_\_\_\_  
**Double top**

UL number : **E 175084**

**E** Electronic **M** Magnetic **C** Short **L** Long

**AVAILABLE TRIMS**  
FR8C, FR8O, FR8OLA, FR8OLB, FR8T

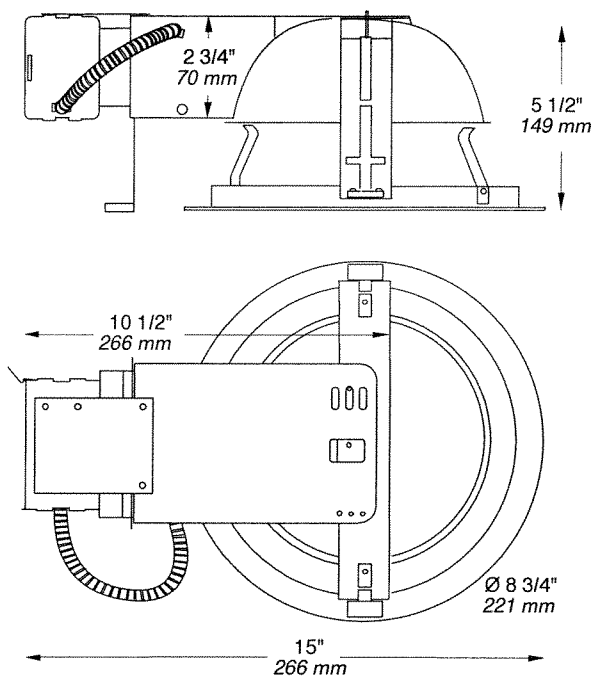

 **OD Cut : 9 1/4" (235 mm)**

NOTES:  
For ceiling without insulation  
Below ceiling access



**PROJECT**

Your Project: \_\_\_\_\_  
\_\_\_\_\_

Representative: \_\_\_\_\_



1009, rue du Parc Industriel, Saint-Jean-Chrysostome, Quebec, CANADA G6Z 1C5 Tel.: (418) 839-4624  
Toll free fax : 1-877-839-7057 Email : info@contrastlighting.com Website : www.contrastlighting.com

09 2006