









# SPECIFICATION SHEET

"NON-IC" TYPE HOUSING

**F8326 - F8332 - F8342**  
**F8U26 - F8U32 - F8U42**

**PROJECT No:**

|                                                                                   |                         |
|-----------------------------------------------------------------------------------|-------------------------|
|  | _____                   |
|                                                                                   | yes                     |
| <b>VOLTAGE</b>                                                                    | 120 / 277 / 347 VOLTS   |
|  | _____                   |
|  | _____                   |
|  | _____                   |
|  | 2 X 26W G24q-3 4PIN DTT |
|  | 2 X 32W G24q-4 4PIN TTT |
|  | 2 X 42W G24q-4 4PIN TTT |
|  | Electronic Ballast      |
|  | _____                   |
| <b>Double top</b>                                                                 | _____                   |
| <b>UL number :</b>                                                                | E 175084                |

**E** Electronic **M** Magnetic **C** Short **L** Long

**AVAILABLE TRIMS**  
 FR8C, FR8O, FR8OLA, FR8OLB, FR8T

 **OD Cut : 9 1/4" (235 mm)**

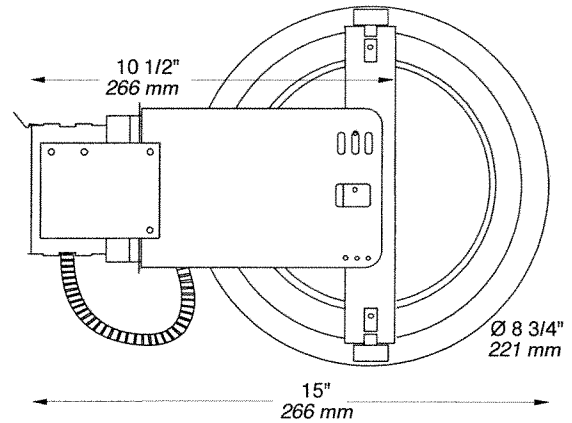
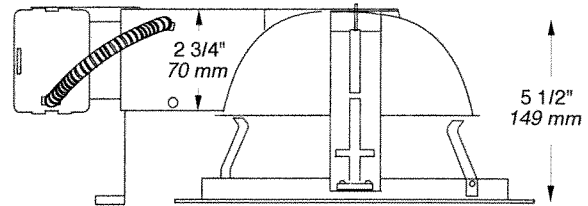

## TECHNICAL SPECIFICATIONS

|                                                                                                                                                                                                                                                                      |                                                                                                                                                                                                                                 |                                                                                                                                                                                                                                                                                                                                                                                   |                                                                                                                                                                                                                                                                                   |                                                                                                       |
|----------------------------------------------------------------------------------------------------------------------------------------------------------------------------------------------------------------------------------------------------------------------|---------------------------------------------------------------------------------------------------------------------------------------------------------------------------------------------------------------------------------|-----------------------------------------------------------------------------------------------------------------------------------------------------------------------------------------------------------------------------------------------------------------------------------------------------------------------------------------------------------------------------------|-----------------------------------------------------------------------------------------------------------------------------------------------------------------------------------------------------------------------------------------------------------------------------------|-------------------------------------------------------------------------------------------------------|
| <p><b>HOUSING FEATURES</b><br/>                 Galvanized steel<br/>                 Preset socket assembly and Keyhole on socket assembly for easier installation<br/>                 Below ceiling accessible<br/>                 See specs housing section</p> | <p><b>LOCKING SYSTEM</b><br/>                 Perfect fit to ceiling<br/>                 No light leak<br/>                 Hooks PAT#CAN.2.088.648 and #USA.5.377.088<br/>                 Take up to 7/8" thick ceilings</p> | <p><b>BALLAST</b><br/>                 120V thru 277V Class P<br/>                 HPF Electronic ballast<br/>                 347V HPF Elect. ballast*<br/>                 (*available in Canada<br/> <b>For ordering change U to 3</b><br/>                 Program start without flickering<br/>                 10% THD and End of life lamp protection, 5 Year Warranty</p> | <p><b>SOCKET</b><br/>                 High temperature-rated<br/>                 130° C instead of 90° C<br/>                 Stainless Steel contacts</p> <p><b>REFLECTOR</b><br/>                 0,04" aluminium reflector with Low Iridescent Semi Specular Clear finish</p> | <p><b>LISTINGS</b><br/>                 UL-cUL Listed for through branch wiring and damp location</p> |
|----------------------------------------------------------------------------------------------------------------------------------------------------------------------------------------------------------------------------------------------------------------------|---------------------------------------------------------------------------------------------------------------------------------------------------------------------------------------------------------------------------------|-----------------------------------------------------------------------------------------------------------------------------------------------------------------------------------------------------------------------------------------------------------------------------------------------------------------------------------------------------------------------------------|-----------------------------------------------------------------------------------------------------------------------------------------------------------------------------------------------------------------------------------------------------------------------------------|-------------------------------------------------------------------------------------------------------|

Your Project: \_\_\_\_\_

Representative: \_\_\_\_\_

