









SPECIFICATION SHEET

"NON-IC" REMODEL TYPE HOUSING

F7313 - F7318 - F7326
F7U13 - F7U18 - F7U26

PROJECT No:

	yes
VOLTAGE	120 / 277 / 347 VOLTS
	
	
	
	2 X 13W G24q-1 4PIN DTT
	2 X 18W G24q-2 4PIN DTT
	2 X 26W G24q-3 4PIN DTT
	Electronic Ballast
	
Double top	
UL number :	E 175084

E Electronic **M** Magnetic **C** Short **L** Long

AVAILABLE TRIMS
 FR7C, FR7O, FR7OLA, FR7OLB, FR7T

 **OD Cut : 8" (203 mm)**

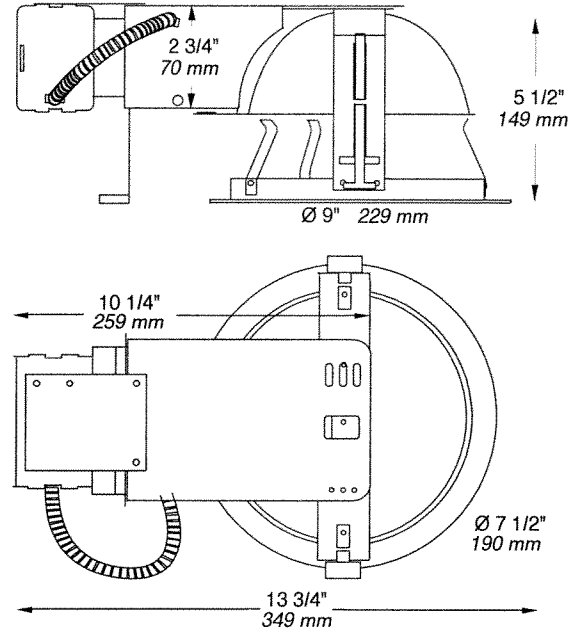

TECHNICAL SPECIFICATIONS

<p>HOUSING FEATURES Galvanized steel Preset socket assembly and Keyhole on socket assembly for easier installation Below ceiling accessible See specs housing section</p>	<p>LOCKING SYSTEM Perfect fit to ceiling No light leak Hooks PAT#CAN.2.088.648 and #USA.5.377.088 Take up to 7/8" thick ceilings</p>	<p>BALLAST 120V thru 277V Class P HPF Electronic ballast 347V HPF Elect. ballast* (*available in Canada For ordering change U to 3 Program start without flickering 10% THD and End of life lamp protection, 5 Year Warranty</p>	<p>SOCKET High temperature-rated 130° C instead of 90° C Stainless Steel contacts</p> <p>REFLECTOR 0,04" aluminium reflector with Low Iridescent Semi Specular Clear finish</p>	<p>LISTINGS UL-cUL Listed for through branch wiring and damp location</p>
--	---	--	---	---

Your Project: _____

Representative: _____

