









SPECIFICATION SHEET

"NON-IC" TYPE HOUSING

F2575R

PROJECT No:

	_____
	yes
VOLTAGE	120 VOLTS
	_____
	_____
	_____
	13W 2PIN DTT
	H.P.F.magnetic Ballast
	_____
	_____
BX Length	_____
UL number	E 175084
E Electronic M Magnetic C Short L Long	

TRIM IS REQUIRED

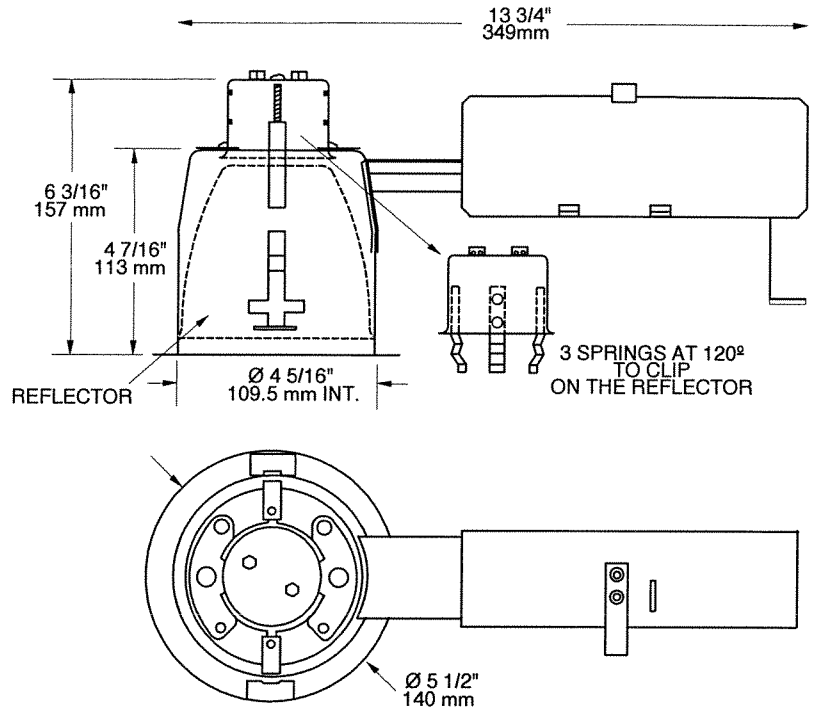

 **OD Cut : 4 5/8" (118 mm)**

NOTES:
For ceiling without insulation
Below ceiling access



PROJECT

Your Project: _____

Representative: _____