









SPECIFICATION SHEET

"NON-IC" TYPE HOUSING

F2000L318 - F2000L326
F2000LU18 - F2000LU26

PROJECT No:

	_____
	yes
VOLTAGE	120 / 277 / 347 VOLTS
	_____
	_____
	_____
	1 X 18W G24q-2 4PIN TTT
	1 X 26W G24q-3 4PIN TTT
	Electronic Ballast
	_____
	_____
BX Length	_____
UL number	E 175084

AVAILABLE TRIMS
 A2400S, A2401S, A2450S, A2451S

 **OD Cut : 4 1/4" (107 mm)**

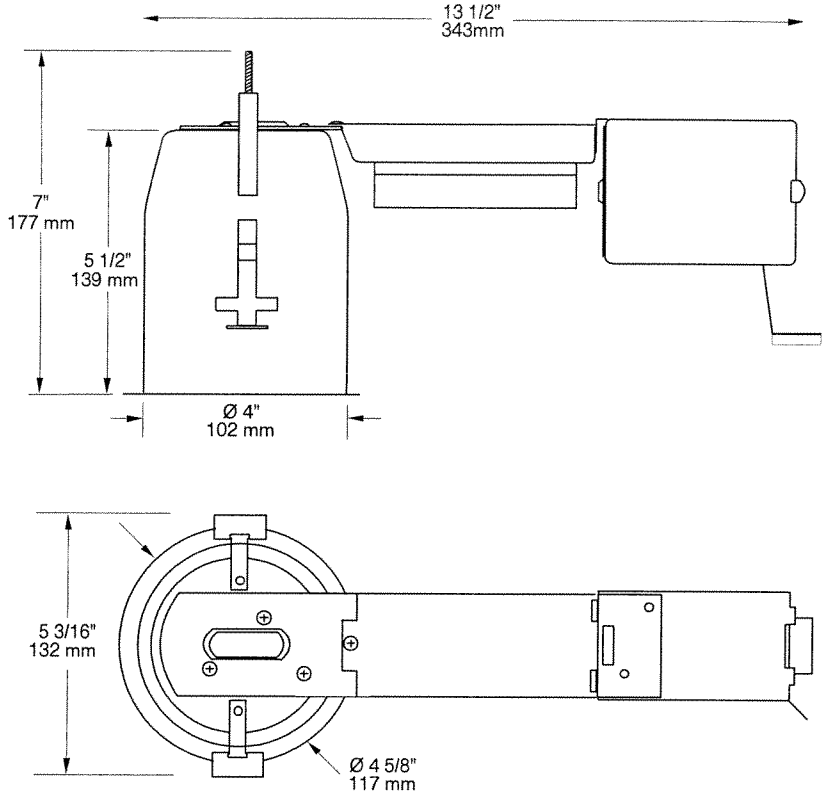

TECHNICAL SPECIFICATIONS

HOUSING FEATURES
 Galvanized steel
 Preset socket assembly and Keyhole on socket assembly for easier installation
 Below ceiling accessible
 See specs housing section

LOCKING SYSTEM
 Perfect fit to ceiling
 No light leak
 Hooks PAT#CAN.2.088.648 and #USA.5.377.088
 Take up to 7/8" thick ceilings

REFLECTOR
 0,04" aluminium reflector with Low Iridescent Semi Specular Clear finish

MOUNTING BARS
 Adjustable and lockable from 10" to 24" lockable integral T-Bar tabs
 May be hung from trusses or suspended ceilings

SOCKET
 High temperature-rated 130° C instead of 90° C
 Stainless Steel contacts

BALLAST
 120V thru 277V Class P HPF Electronic ballast
 347V HPF Elect. ballast*
 (*available in Canada For ordering change U to 3
 Program start without flickering
 10% THD and End of life lamp protection, 5 Year Warranty

LISTINGS
 UL-cUL Listed for through branch wiring and damp location

Your Project: _____

Representative: _____

