







SPECIFICATION SHEET

4" 2000 SERIES

D2000

LOW PROFILE ADJUSTABLE TRIM

	YES
	PAR20 50W
	PAR20 39W HIGH INTENSITY DISCHARGE (HID)
	Insulated ceiling housing ISCA2000D
	New construction housing NW2000CAD
	Remodel housing CA2000D, MH2000DPAR

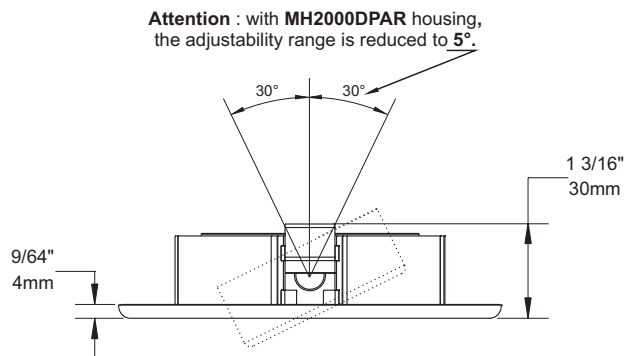
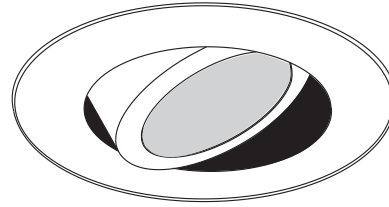

COMPATIBLE HOUSINGS

50W PAR20	39W PAR20 HID
CA2000D NW2000CAD ISCA2000D	MH2000DPAR Attention : with this housing, the adjustability range of the D2000 trim is reduced to 5°.

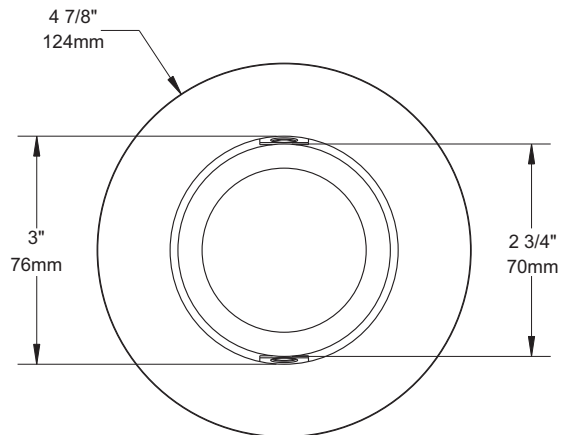

TRIM FINISHES

-01 WHITE	-04BR BRUSHED CHROME	-08 ANTIQUE SILVER
-02 BLACK	-05 ARCHITECTURAL BRONZE	-11 MATTE WHITE
-03 24K GOLD	-06 ANTIQUE COPPER	-12BR BRUSHED NICKEL
-04 CHROME	-07 ANTIQUE BRASS	-13 SATIN NICKEL
		-14 ALMOND

Unless otherwise indicated, trims are for **interior use only**. For exterior use and up to wet conditions, **MARINE GRADE** treatment is **recommended**. Available for finishes -01, -02, -05, -06, -11 and -14 only.



Project _____

Representative _____

CONTRAST
LIGHTING

1009, rue du Parc Industriel, Saint-Jean-Chrysostome, Qc, CAN G6Z 1C5 Tel.: 1-888-839-4624 Fax : 1-877-839-7057
info@contrastlighting.com
www.contrastlighting.com

DECEMBER 2010