







SPECIFICATION SHEET

6" COMPACT FLUORESCENT SERIES

FR6VOLB

TRIM WITH FROSTED LENS FOR VERTICAL LAMP

	YES	
	13W to 42W	
	Standard : Semi-specular low iridescence	
	NWF6VU13, 18, 42	
	F6VU13, 18, 42	

COMPATIBLE HOUSINGS

13W CF	18W CF	26W CF	32W CF	42W CF
F6VU13 NWF6VU13	F6VU18 NWF6VU18	F6VU42 NWF6VU42	F6VU42 NWF6VU42	F6VU42 NWF6VU42



ENERGY STAR® Requirements
120 Volt ONLY

This trim meets every ENERGY STAR requirements when combined with the following housings :

F6VU13 NWF6VU13 F6VU18 NWF6VU18	F6VU42 (42W MAX) NWF6VU42 (42W MAX)
--	--

TRIM FINISHES

-01 WHITE	-04BR BRUSHED CHROME	-08 ANTIQUE SILVER
-02 BLACK	-05 ARCHITECTURAL BRONZE	-11 MATTE WHITE
-03 24K GOLD	-06 ANTIQUE COPPER	-12BR BRUSHED NICKEL
-04 CHROME	-07 ANTIQUE BRASS	-13 SATIN NICKEL
		-14 ALMOND

Unless otherwise indicated, trims are for interior use only. For exterior use and up to wet conditions, **MARINE GRADE** treatment is recommended. Available for finishes -01, -02, -05, -06, -11 and -14 only.

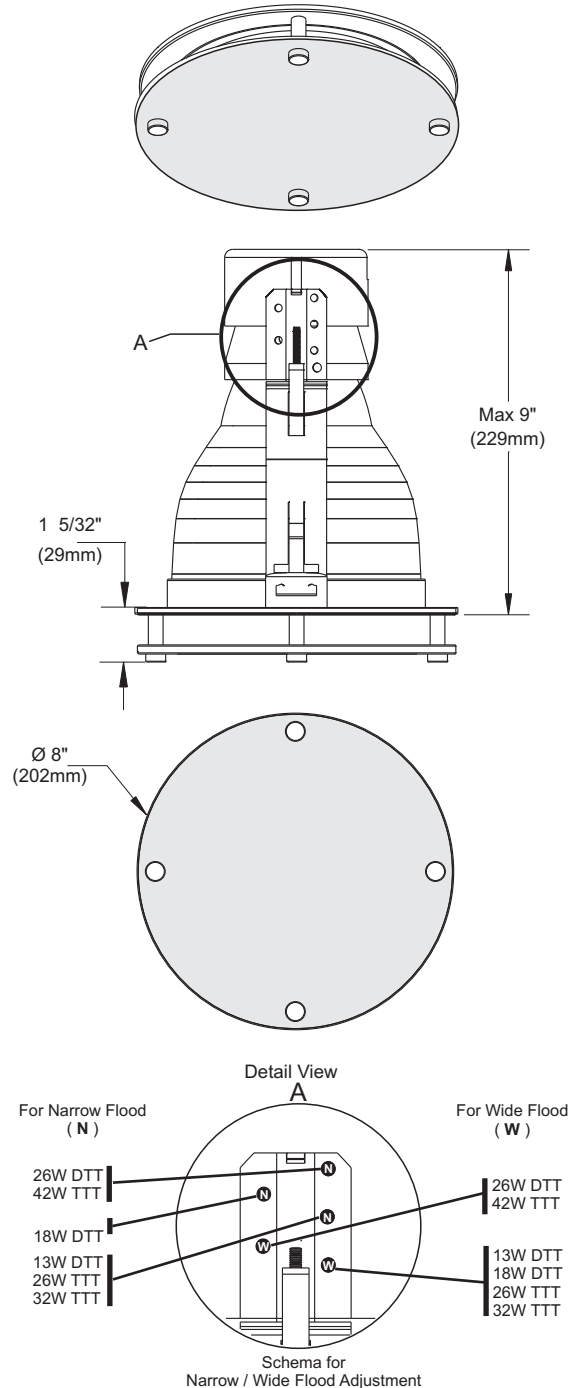

MADE IN CANADA

LISTED
Certified UL Standards

Project _____

Representative _____

CONTRAST
LIGHTING

1009, rue du Parc Industriel, Saint-Jean-Christophe, Qc, CAN G6Z 1C5 Tel.: 1-888-839-4624 Fax : 1-877-839-7057
info@contrastlighting.com
www.contrastlighting.com

NOVEMBER 2010