

SPECIFICATION SHEET

Ardito LED - A3RFD

3-1/2" Series

Project _____

Notes _____

Fixture Type _____

Date _____

Ultra-Thin Profile Round Trim with Frosted Glass Tube



WITH FLANGE

A3RFD-12BR - XXX (illustrated)



FLANGELESS TRIM

A3RFD-TR12BR - XXX (illustrated)

Round, 3-1/2" high efficiency decorative dimmable LED downlight trim. May be installed with a low profile ultra-thin flange or flangeless trim in configuration for insulated, non-insulated and remodel (non-IC) ceilings.

SPECIFICATIONS

COLOR TEMPERATURES 2,700K - 3,000K - 3,500K - 4,000K

CRI 90+

POWER SUPPLY 120V - 277V
 One driver model available in two performances (14W and 23W) and offering 2 dimming options:
 ELV: 120V (14W and 23W) (120V only)
 0-10V: 120V (14W and 23W) (120V only)
 Consult housing specification sheet for more details

Requires a 6-1/2" (165 mm) clearance beyond the ceiling level for standard using and 7" (178 mm) for Lumenetix option using.
 0.036" (0.91 mm) galvanized steel housing

HOUSING DETAILS Perfect fit into ceiling

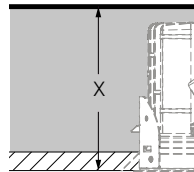

Each part of the housing should be at LEAST 3" (76 mm) from insulation (non-IC configurations)
 Can fit in ceilings up to 1-1/2" (38 mm) thick
 Junction box is accessible from below the ceiling for ease of maintenance



WITH FLANGE

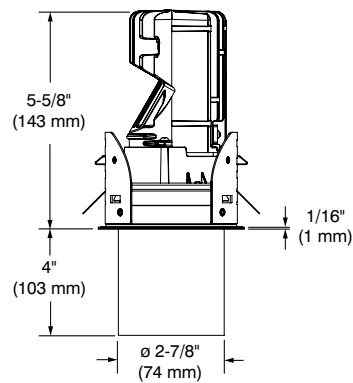

FLANGELESS TRIM

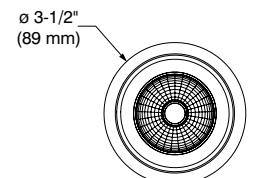
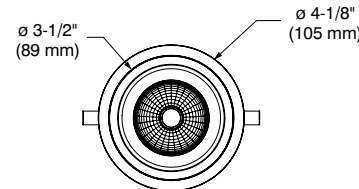
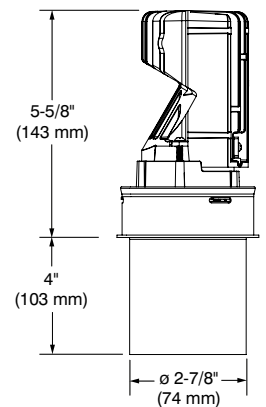

CONTRASTE

1009, rue du Parc Industriel
 Lévis (Québec) G6Z 1C5 Canada
 Tel.: 1-888-839-4624
 Fax.: 1-877-839-7057
 contrastlighting.com
 info@contrastlighting.com

© 2017 Contrast Lighting M.L. Inc.
 All rights reserved

Contrast Lighting M.L. Inc reserves the right to make changes in specifications and/or to discontinue any product at any time without notice or obligation and will not be liable for any consequences resulting from the use of this publication.

Ardito LED - A3RFD

3-1/2" Series

Ultra-Thin Profile Round Trim with Frosted Glass Tube



SPECIFICATIONS (CONT'D)

	Remodel Housing	New Construction Housing	Insulated Housing	Ceiling thickness suggested for insulated housing as a using standard and Lumenetix option.
COMPATIBLE HOUSINGS	Performance 1	REA3V1	NWA3RV1	* ISA3RV1
	Performance 2	REA3V2	NWA3RV2	* ISA3RV2
	Lumenetix	REA3VL	NWA3RVL	** ISA3RVL

* Ceiling thickness must be at least 1/4" (6.4 mm) for insulated housing as a using standard.

** Ceiling thickness must be at least 3/4" (19 mm) for insulated housing with Lumenetix option.

For dimming, please visit our Web site frequently to find our dimmer compatibility list:
www.contrastlighting.com

MUD-IN-PLATE **MIPA3R** (sold separately)
 Consult housing specification sheet for more details.

DELIVERED LUMENS **Performance 1 (14W) Standard:** 795 lumens @ 3,000K, 58.5 lm/W
Performance 2 (23W) Standard: 1,153 lumens @ 3,000K, 50 lm/W
Lumenetix (12.5W): up to 700 lumens

Standard:
 Lumileds Luxeon CoB 1205 GEN2 and CoB 1203 GEN2 (Spot Beam Only) deliver a lumen maintenance greater than 70% after 50,000 hours of operation (L_{70}). Provide a high quality true color and a clean white light without hot spots. Color binning within 3 steps on MacAdam ellipse which surpasses ANSI binning requirements.

Lumenetix Warm Dimming:
 Lumenetix Araya DDM1 Dynamic Dimming Module delivers dimmable white light that warms as it dims, reproducing dimming conditions of a halogen lamp. It allows the user to change the color temperature from 3,050K at full intensity to 1,800K at minimum intensity all this while ensuring a 90+ CRI over the full dimming range.
 Lumenetix: 120V - 277V (12.5W)

Lumenetix Color Tuning:
 Lumenetix Araya CTM1 Color Tuning Module allows the user to program millions of color combinations using a user-friendly Bluetooth application available on iOS mobile devices. The application allows programming of different scenes, colors, and color temperatures while the day-to-day control is ensured by standard 0-10V wall mounted dimmers. 90+ CRI.
 Lumenetix: 120V - 277V (12.5W)

TRIM AND REFLECTOR FINISHES Powder coated paint or plated die formed steel.
 Different finishes available: 24K Gold Plated **(-03)**, Chrome **(-04)**, Brushed Chrome **(-04BR)**, Matte White **(-11)**, Brushed Nickel **(-12BR)**, Satin Nickel **(-13)** and Matte Black **(-22)**

FLANGELESS TRIM Steel mud-in-plate for flangeless trim, allows you to apply plaster up to Ardito fixture opening edges.
 For this option, please refer to ordering code.

CONTRASTE

1009, rue du Parc Industriel
 Lévis (Québec) G6Z 1C5 Canada
 Tel.: 1-888-839-4624
 Fax.: 1-877-839-7057
 contrastlighting.com
 info@contrastlighting.com

© 2017 Contrast Lighting M.L. Inc.
 All rights reserved

Contrast Lighting M.L. Inc reserves the right to make changes in specifications and/or to discontinue any product at any time without notice or obligation and will not be liable for any consequences resulting from the use of this publication.

SPECIFICATION SHEET

Ardito LED - A3RFD

3-1/2" Series

Ultra-Thin Profile Round Trim with Frosted Glass Tube

SPECIFICATIONS (CONT'D)

Interchangeable optional optical reflectors and lenses available to customize your lighting.

Choice of available lenses: Standard - Frosted (included)

Lens (sold separately): Clear, Frosted, Honeycomb, Linear, Prismatic, Solite (refer to page 6 for more details)

OPTIC SYSTEM

Standard

Medium Spot	19°
-------------	-----

* Consult .ies files on our Website for more details.

HEAT SINK

High quality aluminum injected heat sink ensuring maximum heat dissipation

THERMAL PROTECTION

Performance 1 : TC 100°C (212°F)

Performance 2 : TC 100°C (212°F)

Lumenetix : TC 90°C (194°)

CEILING CUTOUT

ø 3-3/4" (95 mm)

CERTIFICATION

- cULus **E343977** for damp locations
- Certified Air Tight ASTM E283

WARRANTY

1 year on components against manufacturing defects

5 years on LED arrays and drivers

CONTRASTE

1009, rue du Parc Industriel
Lévis (Québec) G6Z 1C5 Canada
Tel.: 1-888-839-4624
Fax.: 1-877-839-7057
contrastlighting.com
info@contrastlighting.com

© 2017 Contrast Lighting M.L. Inc.
All rights reserved

Contrast Lighting M.L. Inc reserves the right to make changes in specifications and/or to discontinue any product at any time without notice or obligation and will not be liable for any consequences resulting from the use of this publication.

Ardito LED - A3RFD

3-1/2" Series

Ultra-Thin Profile Round Trim with Frosted Glass Tube

PHOTOMETRIC DATA



3,000K, 90+ CRI, Flood, Performance 1

CANDLEPOWER DISTRIBUTION

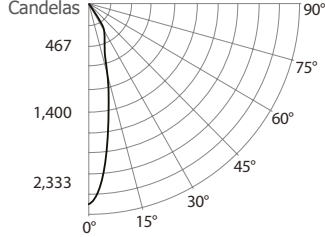

LIGHT CONE

Distance	FC	DIA
06'	5.4	2.0'
08'	40.6	2.6'
10'	26	3.3'
12'	18.1	3.9'
14'	13.3	4.6'
16'	10.2	5.2'

Beam: 19°
Beam Edge defined as 50% of Maximum Nadir Candle-power.

LUMINAIRE

Performance 1 LED	3,000K Flood	
CBCP / Lumens	2 600	/ 797,5
Watts	120V	277V
	13.63W	13.97W
Operating AMPS	0.19A	0.084A
Lumen Maintenance	L70 @ 50,000 Hrs	
CRI	90+	
Lumens/Watt	58,5	
Spacing Criteria	0.61	

COEFFICIENT OF UTILIZATION - %

Ceiling Reflect %	80		50		30	
	50	30	50	30	50	30
Wall Reflect %						
RCR	0	119 119	111 111	106 106		
	2	100 95	95 91	91 88		
	4	87 80	83 78	81 77		
	6	77 71	75 70	73 69		
	8	70 64	68 63	67 63		
	10	65 59	63 58	63 58		

Zonal Cavity Method

Effective Floor Cavity Reflectance 20%

ZONAL LUMEN SUMMARY

ZONE	LUMENS	%LUMINAIRE
0-30	537.8	67.3%
0-40	595.9	74.6%
0-60	709.1	88.8%
60-90	88.5	11.1%
0-90	797.5	100%

CANDELAS DISTRIBUTION

DEGREES/ VERTICAL	CANDELAS	DEGREES/ VERTICAL	CANDELAS
0	2,600	40	89
5	2,079	50	67
10	1,176	60	48
15	564	70	33
20	436	80	21
25	269	90	7
30	95		

3,000K, 90+ CRI, Flood, Performance 2

CANDLEPOWER DISTRIBUTION

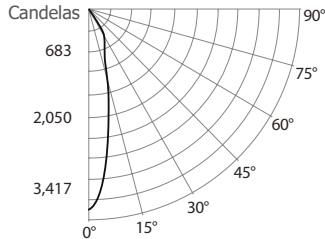

LIGHT CONE

Distance	FC	DIA
06'	5.4	2.0'
08'	60.2	2.6'
10'	38.5	3.3'
12'	26.8	3.9'
14'	19.7	4.6'
16'	15.1	5.3'

Beam: 19°
Beam Edge defined as 50% of Maximum Nadir Candle-power.

LUMINAIRE

Performance 2 LED	3,000K Flood	
CBCP / Lumens	3,853	/ 1,153.6
Watts	120V	277V
	23.05W	23.29W
Operating AMPS	0.10A	0.08A
Lumen Maintenance	L70 @ 50,000 Hrs	
CRI	90+	
Lumens/Watt	50	
Spacing Criteria	0.61	

COEFFICIENT OF UTILIZATION - %

Ceiling Reflect %	80		50		30	
	50	30	50	30	50	30
Wall Reflect %						
RCR	0	119 119	111 111	106 106		
	2	100 95	95 92	92 89		
	4	87 81	84 79	82 78		
	6	78 72	76 71	74 70		
	8	71 65	69 64	68 64		
	10	66 60	64 59	64 59		

Zonal Cavity Method

Effective Floor Cavity Reflectance 20%

ZONAL LUMEN SUMMARY

ZONE	LUMENS	%LUMINAIRE
0-30	797.0	69%
0-40	881.2	76.3%
0-60	1,040.5	90.1%
60-90	113.1	9.8%
0-90	1,153.6	100%

CANDELAS DISTRIBUTION

DEGREES/ VERTICAL	CANDELAS	DEGREES/ VERTICAL	CANDELAS
0	3,853	40	127
5	3,084	50	95
10	1,748	60	66
15	835	70	43
20	643	80	24
25	395	90	7
30	138		

CONTRASTE

1009, rue du Parc Industriel
Lévis (Québec) G6Z 1C5 Canada
Tel.: 1-888-839-4624
Fax.: 1-877-839-7057
contrastlighting.com
info@contrastlighting.com

© 2017 Contrast Lighting M.L. Inc.
All rights reserved

Contrast Lighting M.L. Inc reserves the right to make changes in specifications and/or to discontinue any product at any time without notice or obligation and will not be liable for any consequences resulting from the use of this publication.

Ardito LED - A3RFD

3-1/2" Series

Ultra-Thin Profile Round Trim with Frosted Glass Tube



TRIM WITH FLANGE CODIFICATION EXAMPLE

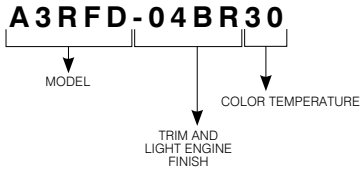

TRIM WITH FLANGE ORDERING CODE **A3RFD**

MODEL	TRIM AND LIGHT ENGINES FINISHES	COLOR TEMPERATURES
A3RFD		
A3RFD	-03 24K Gold Plated	27 2,700K
	-04 Chrome	30 3,000K
	-04BR Brushed Chrome	35 3,500K
	-11 Matte White	40 4,000K
	-12BR Brushed Nickel	CT Color Tuning
	-13 Satin Nickel	WD Warm Dimming
	-22 Matte Black	

FLANGELESS TRIM OPTION CODIFICATION EXAMPLE

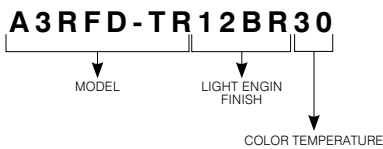

FLANGELESS TRIM OPTION ORDERING CODE **A3RFD-TR** (see next page for mud-in-plate ordering code)

MODEL	LIGHT ENGIN FINISHES	COLOR TEMPERATURES
A3RFD-TR		
A3RFD-TR	03 24K Gold Plated	27 2,700K
	04 Chrome	30 3,000K
	04BR Brushed Chrome	35 3,500K
	11 Matte White	40 4,000K
	12BR Brushed Nickel	CT Color Tuning
	13 Satin Nickel	WD Warm Dimming
	22 Matte Black	

CONTRASTE

1009, rue du Parc Industriel
Lévis (Québec) G6Z 1C5 Canada
Tel.: 1-888-839-4624
Fax.: 1-877-839-7057
contrastlighting.com
info@contrastlighting.com

© 2017 Contrast Lighting M.L. Inc.
All rights reserved

Contrast Lighting M.L. Inc reserves the right to make changes in specifications and/or to discontinue any product at any time without notice or obligation and will not be liable for any consequences resulting from the use of this publication.

SPECIFICATION SHEET

Ardito LED - A3RFD

3-1/2" Series**Ultra-Thin Profile Round Trim with Frosted Glass Tube**

ORDERING CODE for lenses replacement

For future on-site modifications of the light distribution.

Lenses (to modify light diffusion)Clear: **104036**Prismatic: **104039**Frosted: **317240**Honeycomb: **104040**Linear: **104037**Solite: **104038**

ORDERING CODE for Mud-in-Plate

MIPA3R

Consult housing specification sheet for more details.

CONTRASTE

1009, rue du Parc Industriel
Lévis (Québec) G6Z 1C5 Canada
Tel.: 1-888-839-4624
Fax.: 1-877-839-7057
contrastlighting.com
info@contrastlighting.com

© 2017 Contrast Lighting M.L. Inc.
All rights reserved

Contrast Lighting M.L. Inc reserves the right to make changes in specifications and/or to discontinue any product at any time without notice or obligation and will not be liable for any consequences resulting from the use of this publication.